

# Fusion is an Outstanding Physics Challenge and is Connected to Other Outstanding Challenges

---

December 1999

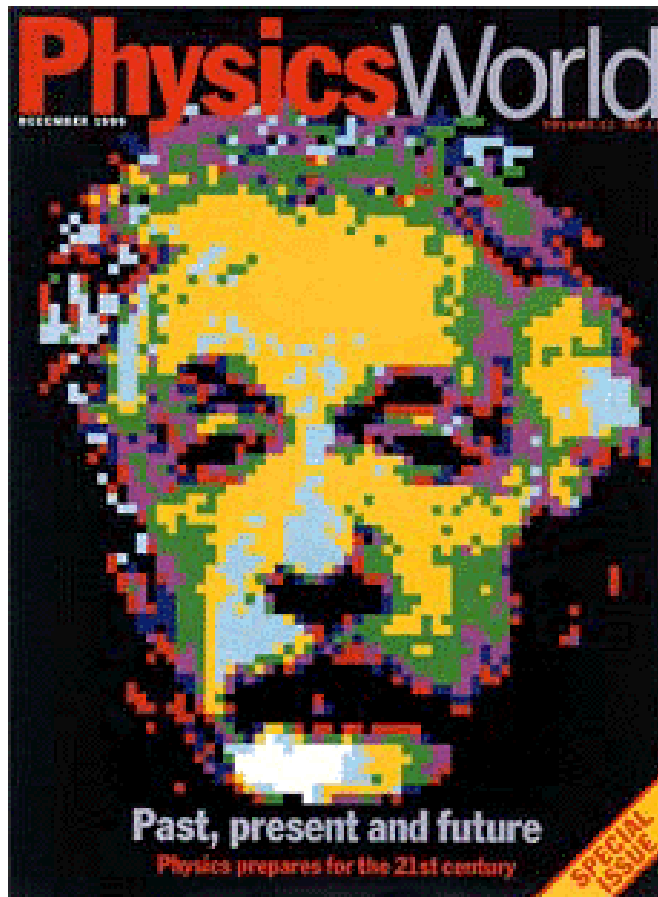

## Ten Outstanding Physics Challenges

---

- Quantum gravity presents the ultimate challenge to theorists
- Explaining high- $T_c$  superconductors
- Unstable nuclei reveal the need for a complete theory of the nucleus
- Realizing the potential of fusion energy
- Climate prediction is heavy weather
- Turbulence nears a final answer
- Glass physics: still not transparent
- Solar magnetic field poses problems
- Complexity, catastrophe and physics
- Consciousness: the physicists view

# **Can we Solve the Mystery of Producing a Stationary Self-Sustained Fusion Fire??**

**Galactic Jet - M87**

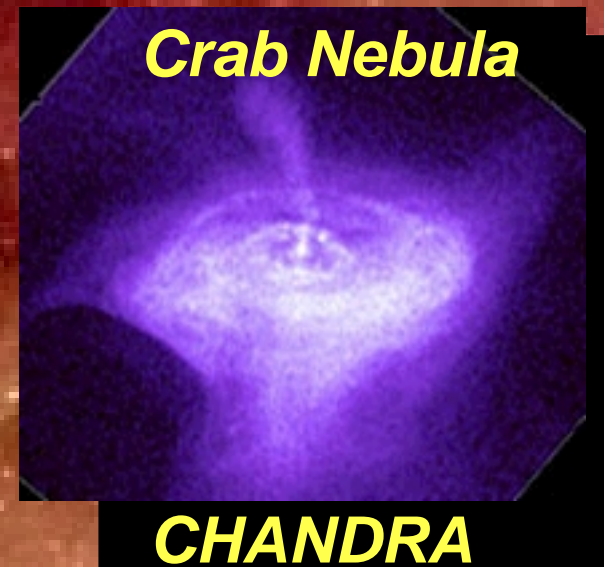
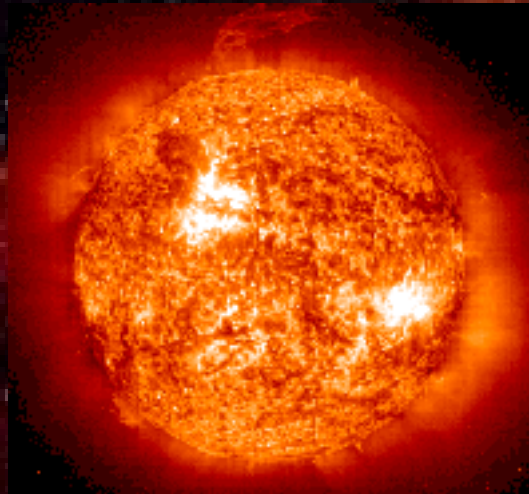
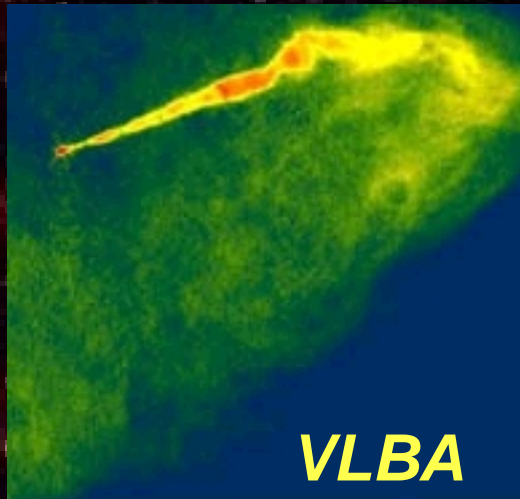

**Fusion: Power of the Cosmos Brought to Earth**

---

# A Brief History of FIRE

Where we are and Future Opportunities.

D. Meade

for the FIRE Team

Presented to

Office of Fusion Energy Science  
Germantown, MD

February 13, 2001

<http://fire.pppl.gov>

**FIRE**

*Lighting the Way to Fusion*



## Outline and Main Points

---

### Rational, Mission, Requirements and Readiness for Burning Plasma Experiment

- a compelling case must be made that has broad support
- UFA Wkp, NSO-PAC and FESAC will help define mission and requirements

### FIRE Scientific Basis and Performance Projections

- evolving in response to community input
- $Q \sim 10$  for 1.5 skin times is goal (requires 7.7 MA @ 10T if ITER98H(y,2))
- add advanced tokamak (RS) capability

### FIRE Engineering Basis

- Baseline wedged BeCu design meets new goals
- Looking for improvements - e.g., bucked and wedged TF

### Plans

# There are Three Principal Fusion Concepts

---

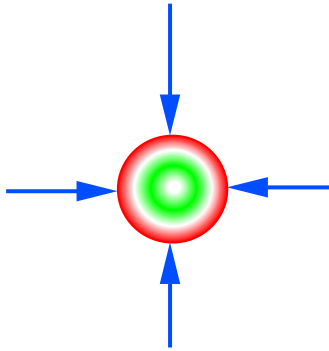

## Spherical Inertial

gravitational

transient compression

drive (laser-D/I, beam)

radial profile

time profile

electrostatic

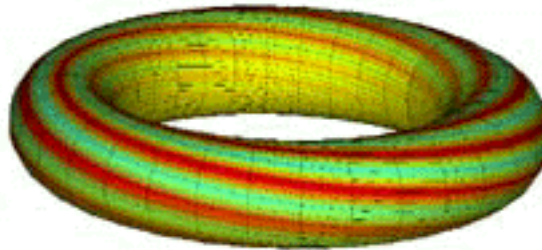

## Toroidal Magnetic

surface of helical B lines

twist of helix

twist profile

plasma profile

toroidal symmetry

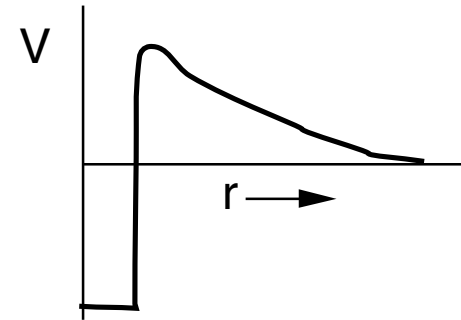

## Reactivity Enhancement

muon catalysis

polarized nuclei

others?

## Issues - Standard Model

	Concept Developm't	Proof of Principle	Performance Extension	Fusion Conditions
Transport				
Macro Stability				
Wave Particle				
Boundary				

Improved Capability (more advanced)

Fusion Conditions {  $(\rho^*, v^*, \beta)$ , edge,  $P_\alpha/P_H$  }

BR<sup>5/4</sup>

## Issues - Strongly Coupled in a Fusion (Burning) Plasma

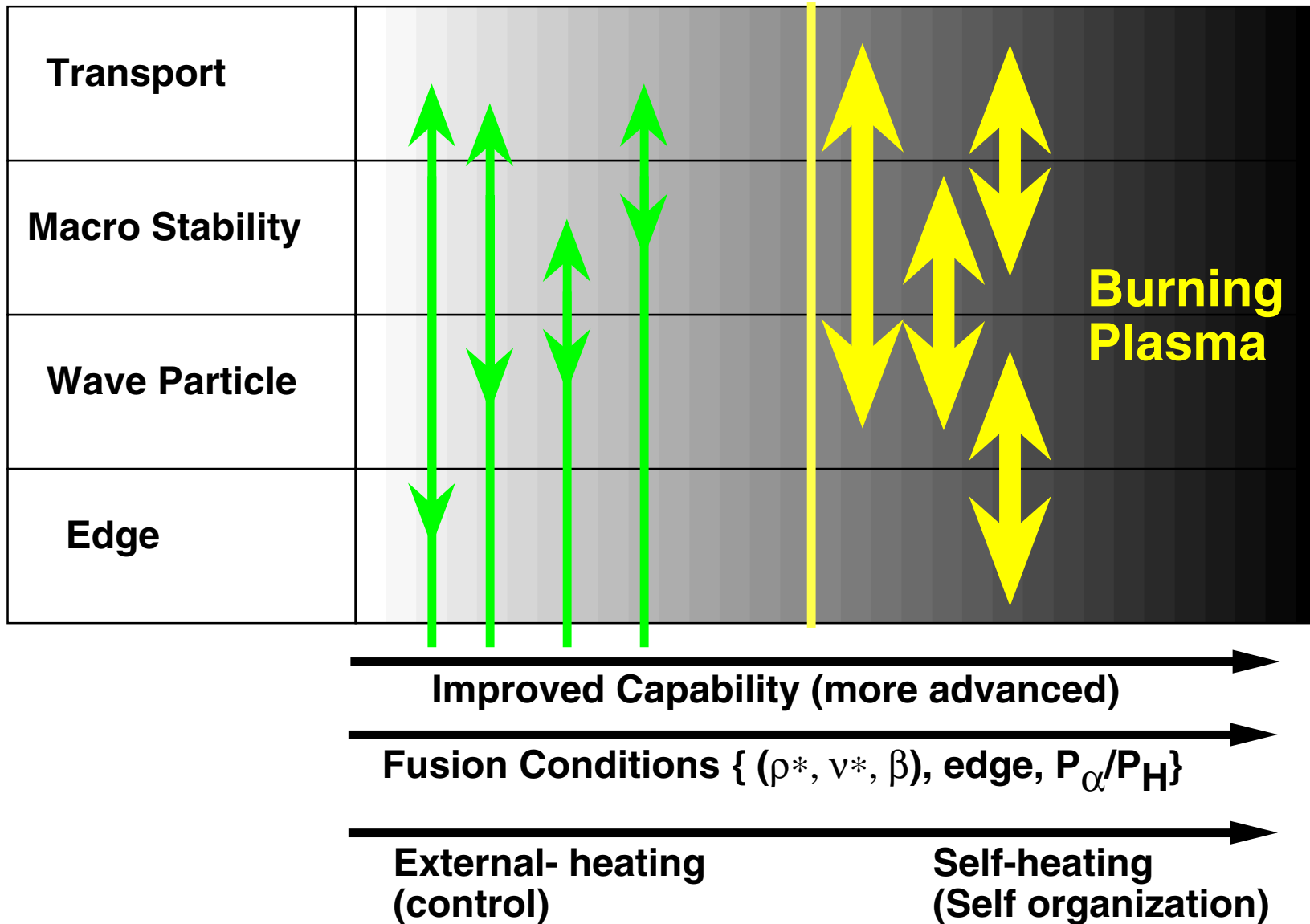

## Burning Plasma Physics is Widely Accepted as the Primary Objective for a Next Step in Fusion Science

---

- Grunder Panel (98) and Madison Forum endorsed Burning Plasmas as next step.
- NRC Interim Report (99) identified “integrated physics of a self-heated plasma” as one of the critical unresolved fusion science issues.
- The Snowmass Fusion Summer Study (99) endorsed the burning plasma physics objective, and that the tokamak was technically ready for high-gain experiment. A burning plasma experiment should also have advanced tokamak capability.
- SEAB (99) noted that “There is general agreement that the next large machine should, at least, be one that allows the scientific exploration of burning plasmas” and if Japan and Europe do not proceed with ITER “the U. S. should pursue a less ambitious machine that will allow the exploration of the relevant science at lower cost.” ..... “In any event the preliminary planning for such a machine should proceed now so as to allow the prompt pursuit of this option.”
- NRC/FuSAC (00) - “The US scientific community needs to take the lead in articulating the goals of an achievable, cost-effective scientific burning plasma experiment, and to develop flexible strategies to achieve it, including international collaboration.”



## NSO/FIRE Community Discussions

---

A Proactive NSO/FIRE Outreach Program has been undertaken to solicit comments and suggestions from the community on the next step in magnetic fusion.

- Presentations have been made and comments received from:

SOFT/France	Sep 98	IAEA/Japan	Oct 98	APS-DPP	Nov 98
FPA	Jan 99	APEX/UCLA	Feb 99	APS Cent	Mar 99
IGNITOR Wkshp	May 99	NRC/NAS	May 99	GAT	May 99
LLNL	May 99	VLT-PAC	Jun 99	MIT PSFC	Jul 99
Snowmass	Jul 99	PPPL/SFG	Aug 99	VLT-PAC	Jun 99
VLT-PAC	Jun 99	MIT PSFC	Jul 99	U. Rochester	Aug 99
NYU	Oct 99	PPPL/SFG	Aug 99	U. Wis	Oct 99
FPA	Oct 99	SOFE	Oct 99	APS-DPP	Nov 99
U. Maryland	Dec 99	DOE/OFES	Dec 99	VLT PAC	Dec 99
Dartmouth	Jan 00	Harvey Mudd	Jan 00	FESAC	Feb 00
ORNL	Feb 00	Northwest'n	Feb 00	U. Hawaii	Feb 00
Geo Tech	Mar 00	U. Georgia	Mar 00	PPPL	Mar 00
Naval Postgrad S	Mar 00	U. Wis	Mar 00/Apr00	EPS/Budapest	Jun 00
IPP/Garching	Jun 00	CEA/Cadarache	Jun 00	JET-EFDA	Jun 00
NSO-PAC	Jul 00	SOFT/Spain	Sep 00	IAEA/Italy	Oct 00
Int'l DB/Frascati	Oct 00	CRPP/Lausanne	Oct 00	ANS/TOFE	Oct 00
APS/DPP-ICPP	Oct 00	VLT-PAC	Dec 00	UFA BP Wkp	Dec 00
NSO-PAC2	Jan 01	MIT IAP	Jan 01	Columbia U.	Jan 01
DOE/OFES	Feb 01				

- The FIRE web site has been developed to make information on FIRE and fusion science accessible and up to date. Over 15,000 visitors from around the world have logged on to the FIRE web site since the site was initiated in July, 1999.

# UFA Workshop on Burning Plasma Science

---

First Workshop - 90 participants- December 11-13, 2000 University of Texas

- Extension of Madison Forum, Snowmass discussions on burning plasmas.
- Focused on Sciences Issues for/by burning plasmas
- Five Science Issue Breakout groups were established:
  1. Energetic Alpha Particles Issues for a Burning Plasma
  2. Confinement, Transport and Self-heating in Burning Plasma
  3. Macro-stability in a Burning Plasma
  4. Boundary Plasma Science
  5. Relationship of Burning Plasma Science to Other Fields
- Strong nonlinear coupling that will occur in a strongly burning plasma was an overall theme. Action Item - need to develop a more compelling case.
- Some sentiment that a BP might be boring, that is, extrapolation too small from existing parameters. Others, expressed concern that strongly burning plasmas in an AT configuration with high bootstrap would be uncontrollable. Several areas identified where tokamak BP would shed light on understanding science issues for other configurations.

## **Next Step Option PAC is Engaged and Active.**

---

- **Members:** Tony Taylor (Chair), Gerald Navratil, Ray Fonck, David Gates, Dave Hill, Wayne Houlberg, Tom Jarboe, Mitsuro Kikuchi, Earl Marmor, Raffi Nazikian, Craig Petty, Rene Raffray, Paul Thomas, James VanDam
- **Meetings**
  - July 20-21, 2000 at General Atomics, San Diego, CA.
  - January 17-18, 2001 at MIT, Cambridge, MA
  - July 11-12, 2001 at Univ. Wisc, Madison, WI
- **Charge for First and Second meetings**
  - Scientific value of a Burning Plasma experiment
  - Scientific readiness to proceed with such an experiment
  - Is the FIRE mission scientifically appropriate?
  - Is the initial FIRE design point optimal?
- Extensive PAC Reports provide detailed recommendations for the FIRE activity to address. NSO-PAC reports are on FIRE (<http://fire.pppl.gov>), will discuss in more detail under FY 2001-03 Plans.

# Common Themes Emerging from NSO-PAC, UFA Workshop and Community Discussions

---

## Scientific Basis

an experiment with flexibility, affordable first step with capability for later upgrades .

able to access fusion dominated ( $P_{\text{fusion}}/P_{\text{heat}} \geq 50\%$ )

increased  $I_p$  6.44 MA to 7.7 MA

plasma sustained at least 1 -2 skin times

reduced aspect ratio to 3.6

increased size  $R = 2.0\text{m}$  to  $2.14\text{m}$

address issues central to fusion science

developing AT scenario for FIRE

## Technical Basis and Status

LN Cu coil tokamak can satisfy the scientific requirements. **What is the optimum config.?**

Baseline Wedged (BeCu) design meets requirements, will start peer review critical systems.

Beginning design of a Bucked and Wedged (Cu) Configuration.

Internal hardware and PFCs are a common challenge for tokamaks and other MF configs.

## Community Involvement

Must develop a **more exciting and compelling case** for a next step magnetic fusion experiment.

Presently an outreach emphasis, **must transition to greater community involvement.**

UFA workshops, Science Initiatives for NSO, etc are opportunities for progress.

# Steps from the Vision to FIRE

---

**Vision** (the public inspiration)  
HEP, NASA

**Mission** (statement for broad physics community)

**Scientific Objectives** (workscope for the fusion/plasma community)

**Plasma Parameters** (needed to address objectives)

**Device Parameters** (needed to produce plasma parameters)

**Project Cost must be affordable (if not reduce the mission)**

# Vision and Mission for a Major Next Step in Magnetic Fusion

---

## FIRE Vision Statement (some suggestions)

- **Lighting the Fusion Fire**
- Lighting the Way to the Future
- Exploring, Explaining and Expanding the frontiers of plasma science

## FIRE Mission Statement

“Attain, explore, understand and optimize ~~alpha~~ fusion-dominated plasmas to provide knowledge for the design of attractive ~~MFE~~ magnetic fusion systems.”

# Fusion Science Objectives for a Major Next Step Magnetic Fusion Experiment

---

**Explore and understand the strong non-linear coupling that is fundamental to fusion-dominated plasma behavior (self-organization)**

- Energy and particle transport (extend confinement predictability)
  - Macroscopic stability (  $\beta$ -limit, wall stabilization, NTMs)
  - Wave-particle interactions (fast alpha particle driven effects)
  - Plasma boundary (density limit, power and particle flow)
- Test/Develop techniques to control and optimize fusion-dominated plasmas.
  - Sustain fusion-dominated plasmas - high-power-density exhaust of plasma particles and energy, alpha ash exhaust, study effects of profile evolution due to alpha heating on macro stability, transport barriers and energetic particle modes.
  - Explore and understand various advanced operating modes and configurations in fusion-dominated plasmas to provide generic knowledge for fusion and non-fusion plasma science, and to provide a foundation for attractive fusion applications.

# Stepping Stones for Resolving the Critical Fusion Plasma Science Issues for an Attractive MFE Reactor

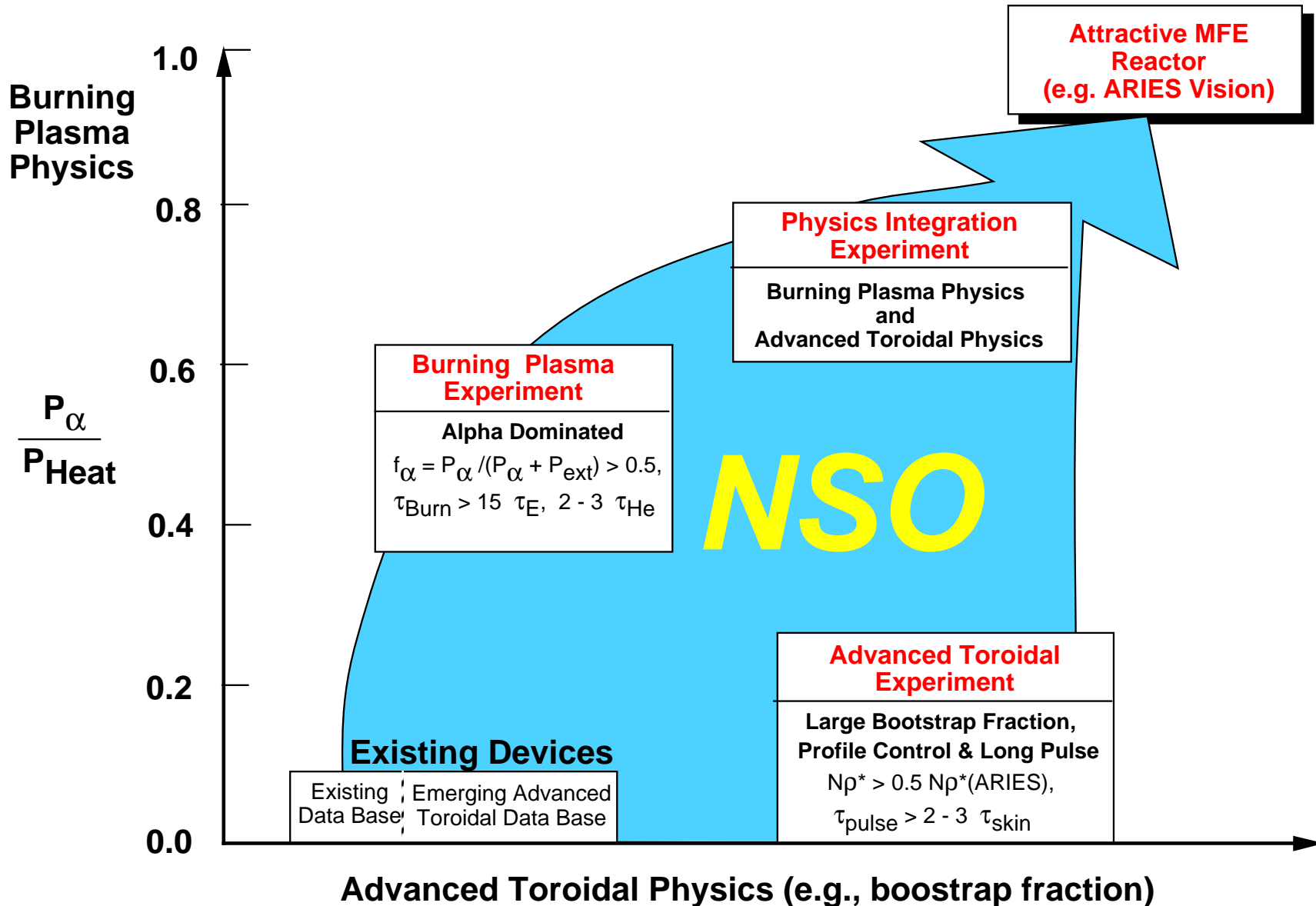

The “Old Paradigm” required three separate devices, the “New Paradigm” could utilize one facility operating in three modes or phases.



# Requirements for a Next Step Burning Plasma Experiment

Note: these are the projections on to the 2-D planes.

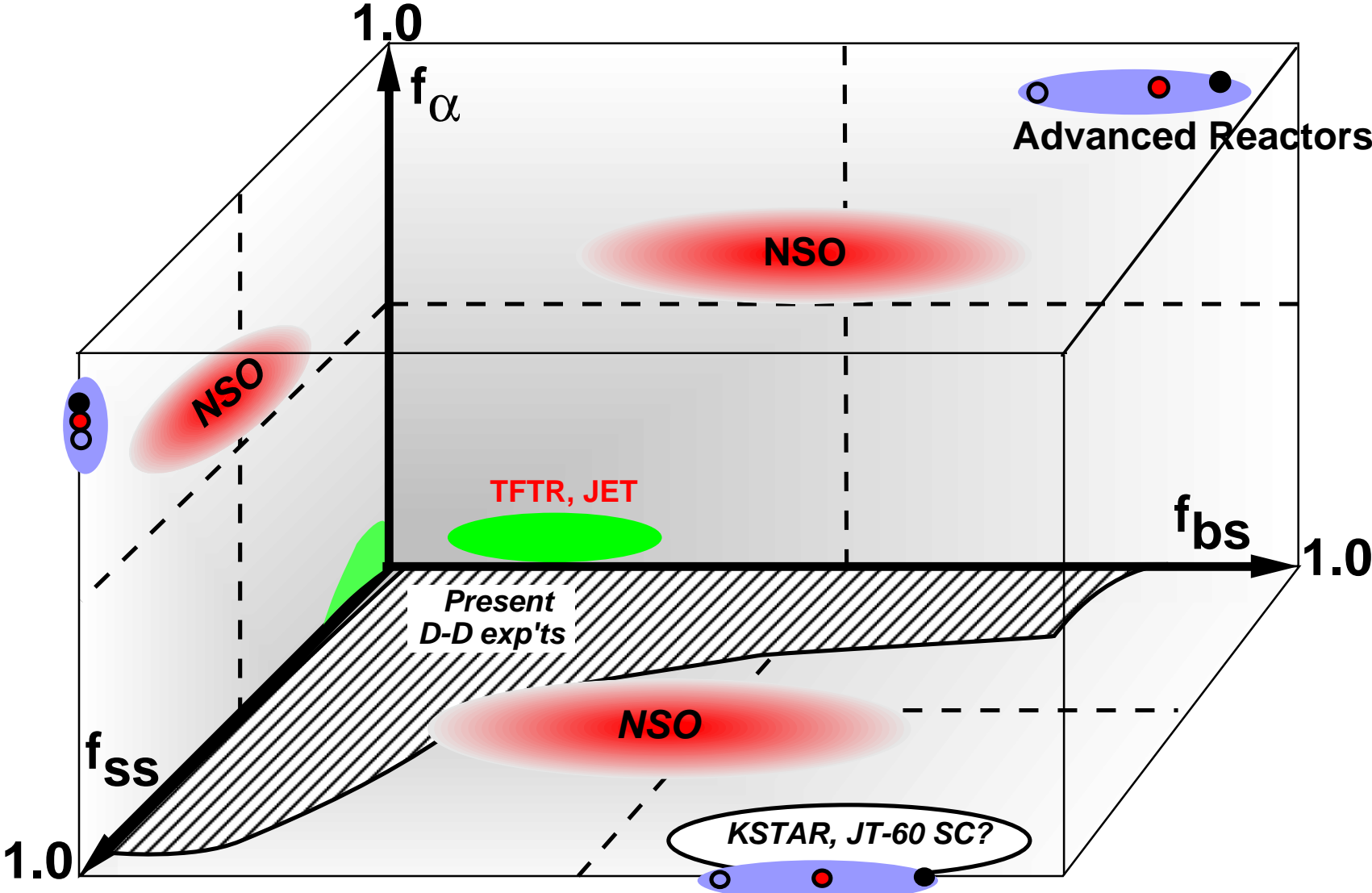

$f_{ss}$  is the plasma current equilibration fraction

## Dimensionless Parameters Required for Fusion Plasma Physics Experiment

	Core*	Edge	Alpha	Duration			
	$BR^{5/4}$	?	$P_\alpha/P_{heat}$	$\tau/\tau_{\alpha s}$	$\tau/\tau_E$	$\tau/\tau_{He}$	$\tau/\tau_{CR}$
<b><u>Explore and Understand Fusion Plasmas</u></b> Energy and Particle Transport Macroscopic Stability Wave Particle (alpha heating, fast alpha) Plasma Boundary	>0.5	?	>0.5  ~ ARIES	>3	>5	>3	>3
<b><u>Test Control and Optimization Techniques</u></b>	>0.5		0.4 to 0.6		10	>3	1
<b><u>Sustain Fusion-Dominated Plasmas</u></b> Exhaust of power, particles and ash Profile evolution impact on E, MHD	>0.5		0.4 to 0.6 0.5 to 0.8		10	3 to 5	1.5 to 3
<b><u>Explore and Understand Some AT Modes</u></b>			0.5 to 0.8		>10	5	1.5 to 3
<b>ARIES-AT</b>	<b>1</b>		<b>0.9</b>	<b>&gt;10</b>	<b>&gt; 10</b>	<b>&gt;10</b>	<b>&gt; 10</b>
<b>FIRE Goals</b>	<b>0.6</b>		<b>0.5 to 0.8</b>	<b>&gt;10</b>	<b>&gt;10</b>	<b>&gt;5</b>	<b>1.5 to 3</b>
<b>JET/TFTR D-T Experiments</b>	<b>0.3</b>		<b>0.04</b>	<b>~3</b>	<b>10</b>	<b>~2</b>	<b>&lt;0.2</b>

\* Core parameters are normalized to ARIES-AT  $BR^{5/4}$

# Dimensionless Parameters for Potential Next Step D-T Plasmas

ITER-FEAT (15 MA):  $Q = 10$ ,  $H = 0.95$ , FIRE\*(7.7 MA):  $Q = 10$ ,  $H = 1.03$ , JET-U (6 MA):  $Q = 0.64$ ,  $H = 1.1$

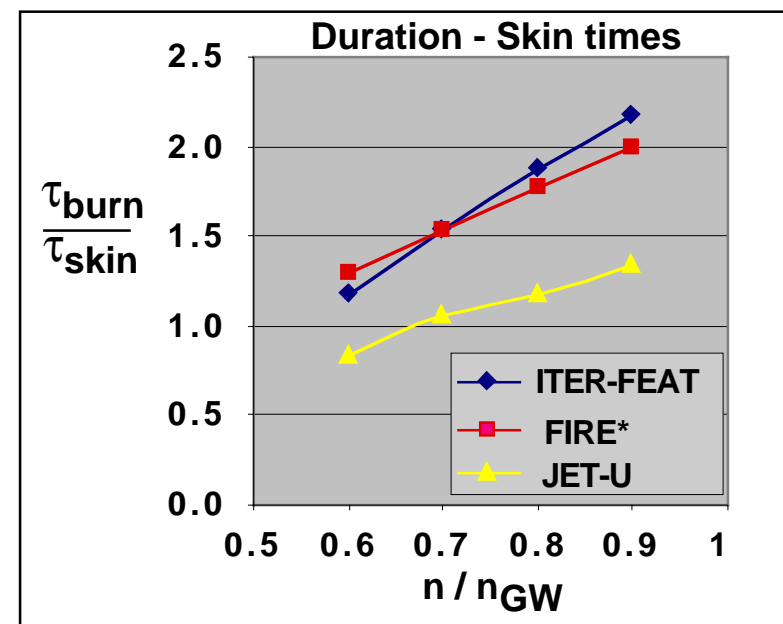
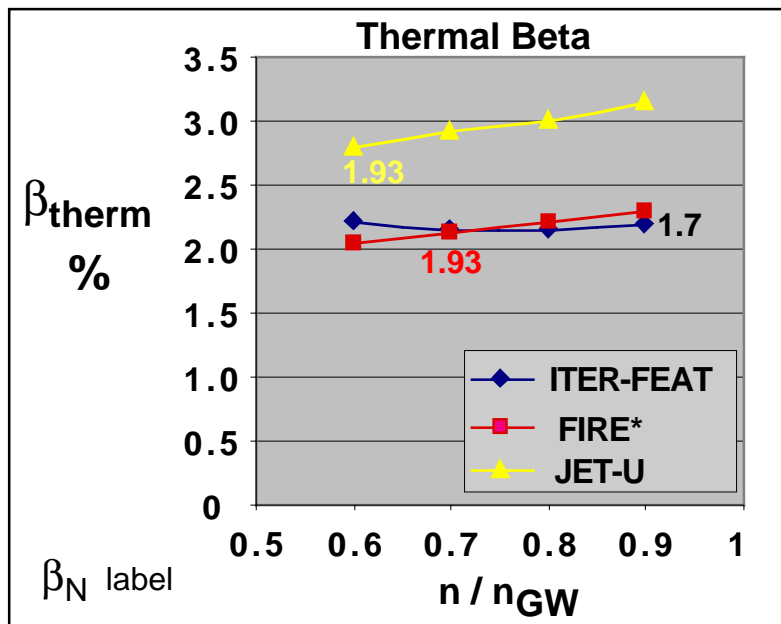
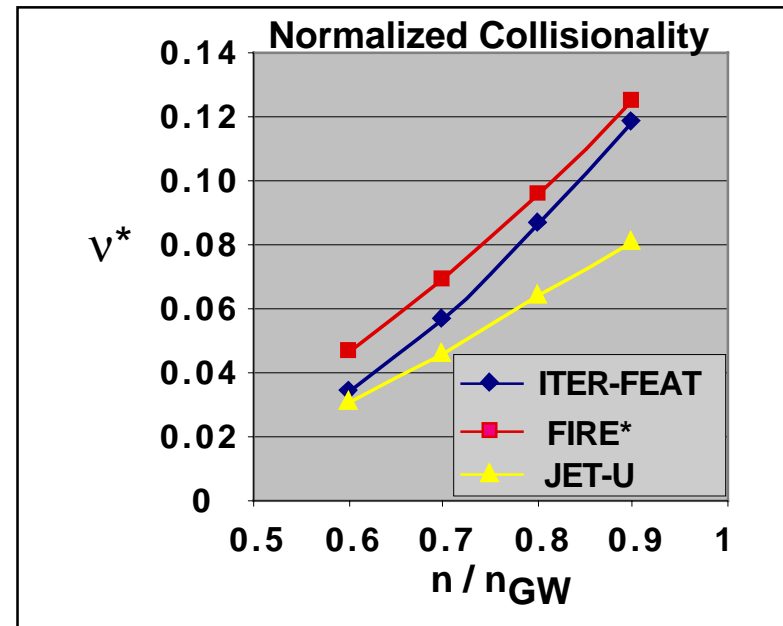
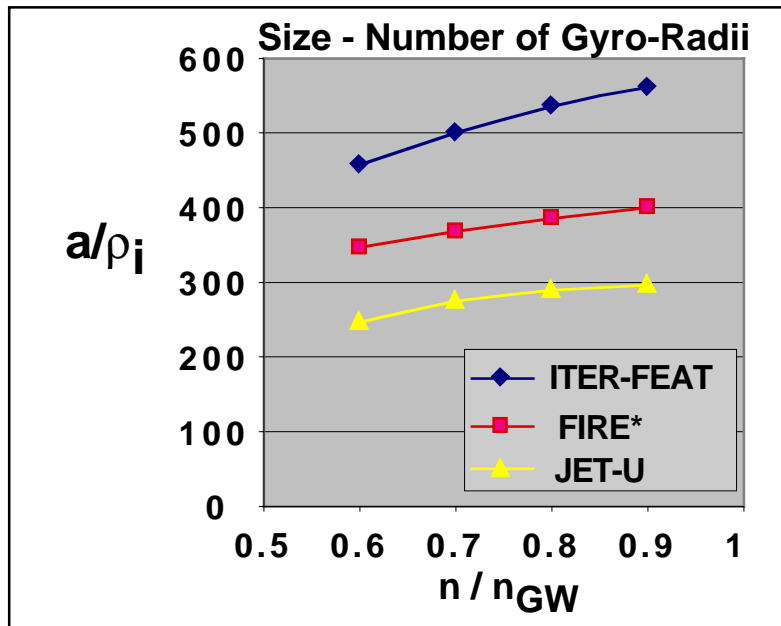

# Dimensionless Parameters for Potential Next Step D-T Plasmas

ITER-FEAT:  $Q = 10$   $H = 0.95$ , FIRE\*:  $Q = 10$ ,  $H = 1.03$ , JET-U:  $Q = 0.64$ ,  $H = 1.1$

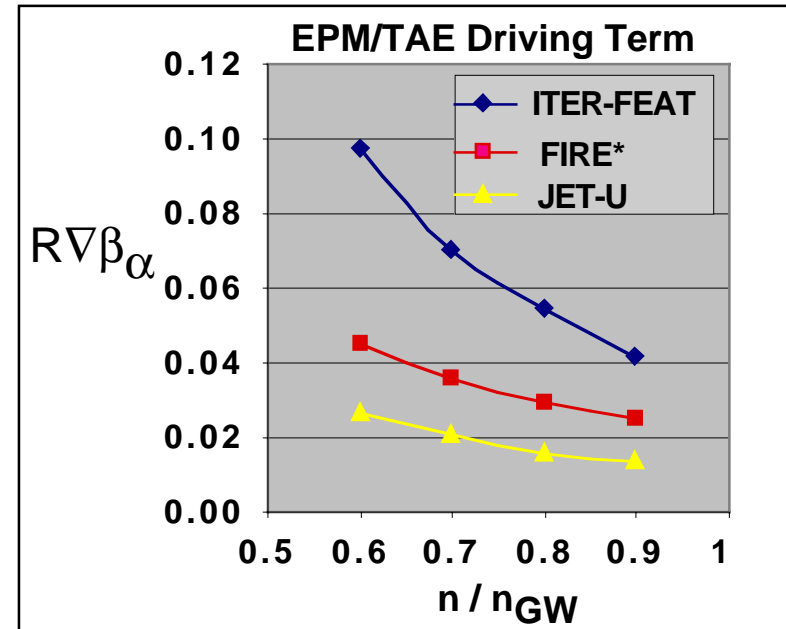
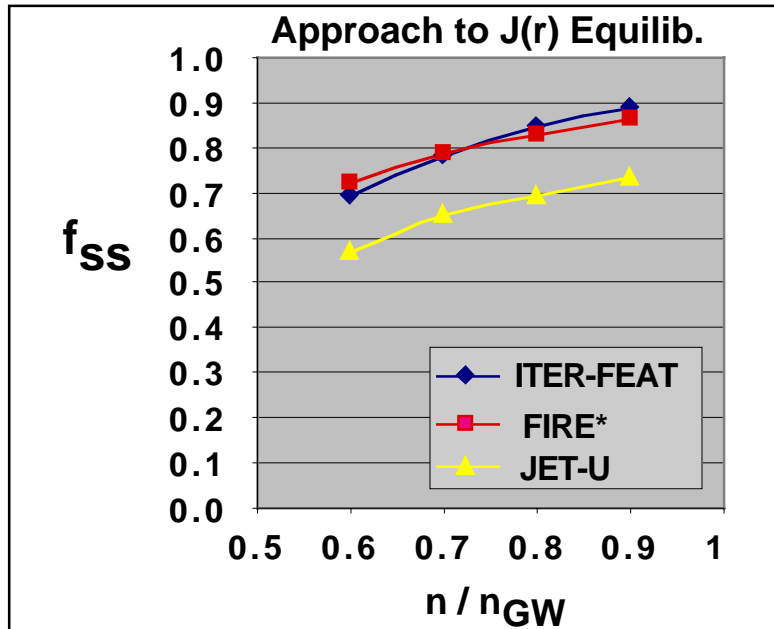

## Summary Points on Dimensionless Parameters

- FIRE is a modest extrapolation in  $\rho^*$  and  $R^*\nabla\beta_\alpha$ , is this good or bad?
- Other FIRE and ITER-FEAT dimensionless parameters are quite close.
- JET-U (4T, 6 MA) parameters are substantially less, esp  $Q$  or  $f_\alpha = P_\alpha/P_{\text{heat}}$ . Large population of RF or NB ions will damp EPM/TAE modes.

## Plans (Ideas) for Vision and Mission Development

---

- Look for guidance from the UFA Burning Plasma Science Workshop Series
  - followup on action items
  - more active involvement of the community
- Respond to FESAC Burning Plasma Review
- Continue outreach activity ~ 30 talks in last 18 months, 1/3 non-fusion audiences
  - extend discussions and visits within the fusion community
  - actively participate/discuss with broader physical sciences community
    - Spring APS in Washington, DC, AAAS meetings, HEP Snowmass?
    - Accelerator laboratories - physics and enabling technology
    - High Field Magnet Community, NASA science and technology
- Extend web site - excellent response from all over the U.S. and world

# Status of Laboratory Fusion Experiments

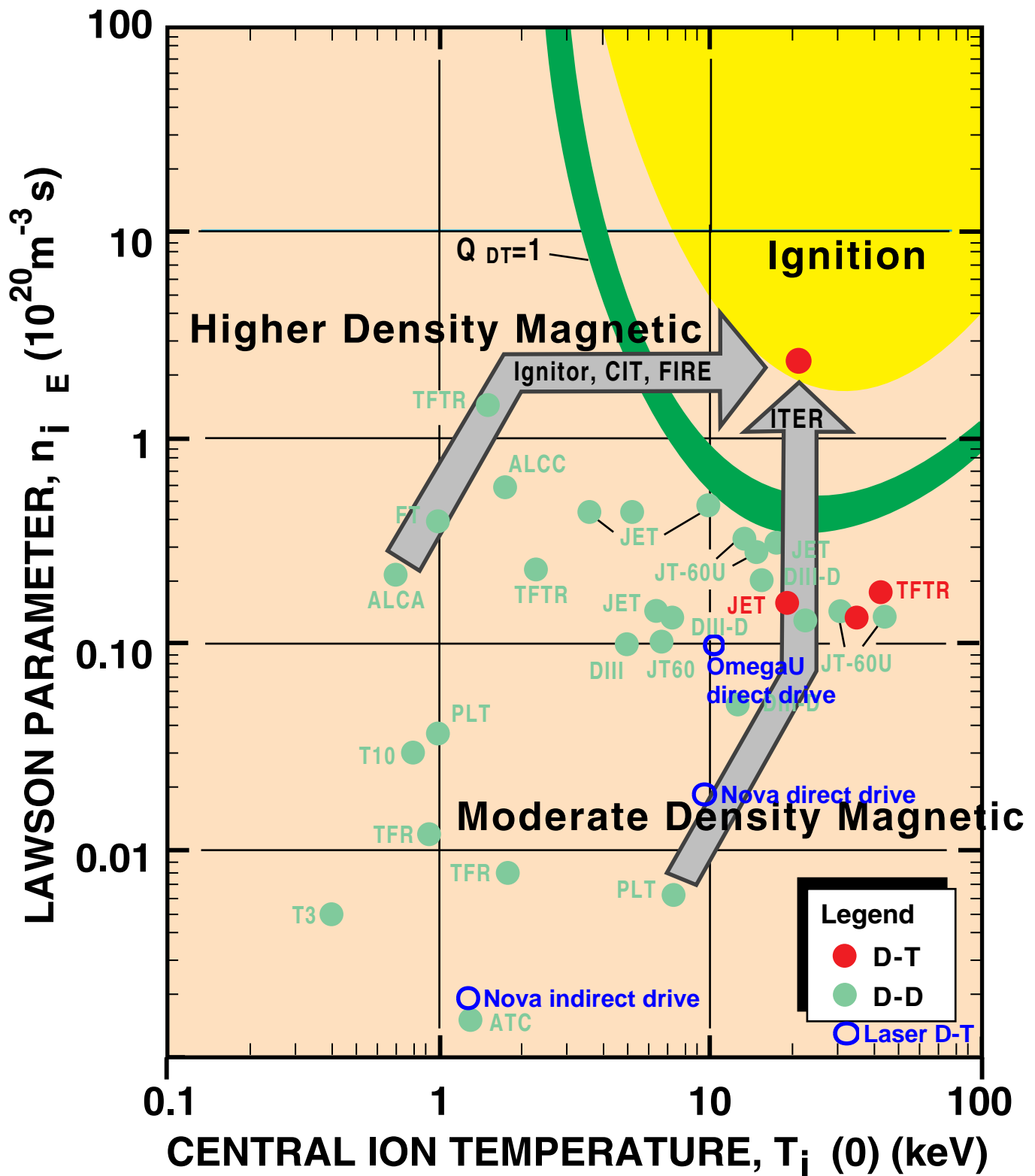

## **Contributors to the FIRE Engineering Design Study**

---

FIRE is a design study for a major Next Step Option in magnetic fusion and is carried out through the Virtual Laboratory for Technology. FIRE has benefited from the prior design and R&D activities on BPX, TPX and ITER.

**Advanced Energy Systems  
Argonne National Laboratory  
DAD Associates  
General Atomics Technology  
Georgia Institute of Technology  
Idaho National Engineering Laboratory  
Lawrence Livermore National Laboratory  
Massachusetts Institute of Technology  
Oak Ridge National Laboratory  
Princeton Plasma Physics Laboratory  
Sandia National Laboratory  
Stone and Webster  
The Boeing Company  
University of Illinois  
University of Wisconsin**

# Fusion Ignition Research Experiment (FIRE)

<http://fire.pppl.gov>

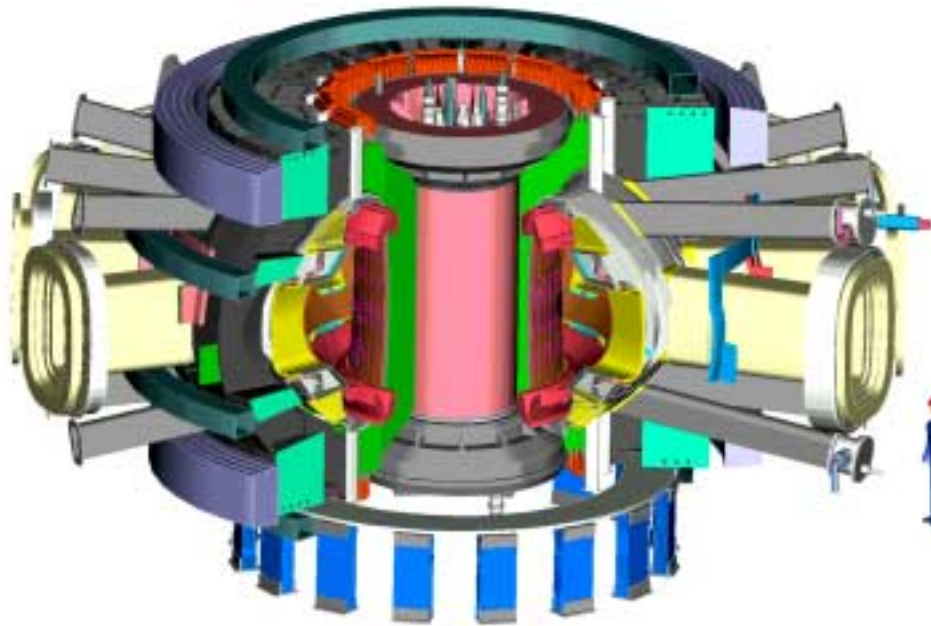

## Design Goals

- $R = 2.0 \text{ m}$ ,  $a = 0.525 \text{ m}$
  - $B = 10 \text{ T}$ ,  $(12\text{T})^*$
  - $W_{\text{mag}} = 3.8 \text{ GJ}$ ,  $(5.5\text{T})^*$
  - $I_p = 6.5 \text{ MA}$ ,  $(7.7 \text{ MA})^*$
  - $P_{\text{alpha}} > P_{\text{aux}}$ ,  $P_{\text{fusion}} < 200 \text{ MW}$
  - Burn Time  $\approx 18.5\text{s}$  ( $\approx 12\text{s}$ )<sup>\*</sup>
  - Tokamak Cost  $\leq \$0.3\text{B}$
- Base Project Cost  $\leq \$1\text{B}$**

Cost goal drives one to the smallest size and constrained mission.

\* Higher Field Mode

**Attain, explore, understand and optimize fusion-dominated plasmas that will provide knowledge for attractive MFE systems.**



## Basic Parameters and Features of FIRE Reference Baseline

R, major radius	2.0 m
a, minor radius	0.525 m
$\kappa_{95}$ , elongation at 95% flux surface	~1.8
$\delta_{95}$ , triangularity at 95% flux surface	~0.4
$q_{95}$ , safety factor at 95% flux surface	>3
Bt, toroidal magnetic field	10 T with 16 coils, 0.34% ripple @ Outer MP
Toroidal magnet energy	3.7 GJ
$I_p$ , plasma current	~6.5 MA (7.7 MA at 12 T)
Magnetic field flat top, burn time	26 s at 10 T in dd, 18.5s @ Pdt ~ 200 MW)
Pulse repetition time	~3hr @ full field and full pulse length
ICRF heating power, maximum	30 MW, 100MHz for $2\Omega_T$ , 4 mid-plane ports
Neutral beam heating	None, may have diagnostic neutral beam
Lower Hybrid Current Drive	None in baseline, upgrade for AT phase
Plasma fueling	Pellet injection ( $\geq 2.5$ km/s vertical launch inside mag axis, possible guided slower speed pellets)
First wall materials	Be tiles, no carbon
First wall cooling	Conduction cooled to water cooled Cu plates
Divertor configuration	Double null, fixed X point, detached mode
Divertor plate	W rods on Cu backing plate (ITER R&D)
Divertor plate cooling	Inner plate-conduction, outer plate/baffle- water
Fusion Power/ Fusion Power Density	200 MW, ~10 MW m <sup>-3</sup> in plasma
Neutron wall loading	~ 3 MW m <sup>-2</sup>
Lifetime Fusion Production	5 TJ (BPX had 6.5 TJ)
Total pulses at full field/power	3,000 (same as BPX), 30,000 at 2/3 Bt and $I_p$
Tritium site inventory	Goal < 30 g, Category 3, Low Hazard Nuclear Facility

**Higher Field Mode B = 12T and  $I_p = 7.7$ MA with a 12 second flat top has been identified. Also enhanced performance option B = 10T,  $I_p = 7.7$  MA with 20 s burn with R = 2.14m**

# **FIRE would have Access for Diagnostics and Heating**

**(and Advanced Tokamak Stabilization Systems)**



**C3PO**

16 mid-plane ports 1.3m x 0.65m  
32 divertor ports 0.5m x 0.2m (16 for cryopumps/cooling water  
24 vertical ports 0.13m diam

## FIRE Status

---

### Physics - NSO PAC review with Action Plan to follow up on Recommendations

- Mission endorsed (recommend even more excitement)
- Evaluate FIRE performance on the basis of recent scalings e.g., ITER98(y,2) and recent results with enhanced regimes e.g., pellet fueling
- Enhanced performance design point has been developed with  $I_p = 7.7$  MA to increase confidence of high gain while maintaining pulse length ( $\sim 1.5$  cr)
- Potential for advanced tokamak modes is being developed

### Engineering

- Pre-Conceptual Design Activity has addressed all subsystems. Engineering Report 2000 completed, see <http://fire.pppl.gov>. CD is available on request
- Baseline design of 10 T /20 s flat top and 12 T/12 s flat top exceeds original design goals of 10 T/10 s flat top.
- Actively cooled W outer divertor and baffle with conduction cooled inner W divertor, and Be first wall on Cu substrate satisfy cooling requirements.
- Cost Estimate of Baseline design gives \$1.2B(FY-99\$) for Green Field site with good possibility of < \$1B(FY-99) at an existing site.
- FIRE\* (7.7 MA, 10 T, 20 s flat top,  $R = 2.14$  m,  $a = 0.595$  m,  $A = 4$ ) is preferred option for increasing plasma performance, and is within original engineering margins for coils and structure. Divertor and first wall similar to baseline.

# FIRE has Advanced Tokamak Capability and Flexibility

## AT Features

- DN pumped divertor
- strong shaping
- very low ripple
- internal coils
- space for wall stabilizers
- inside pellet injection
- large access ports

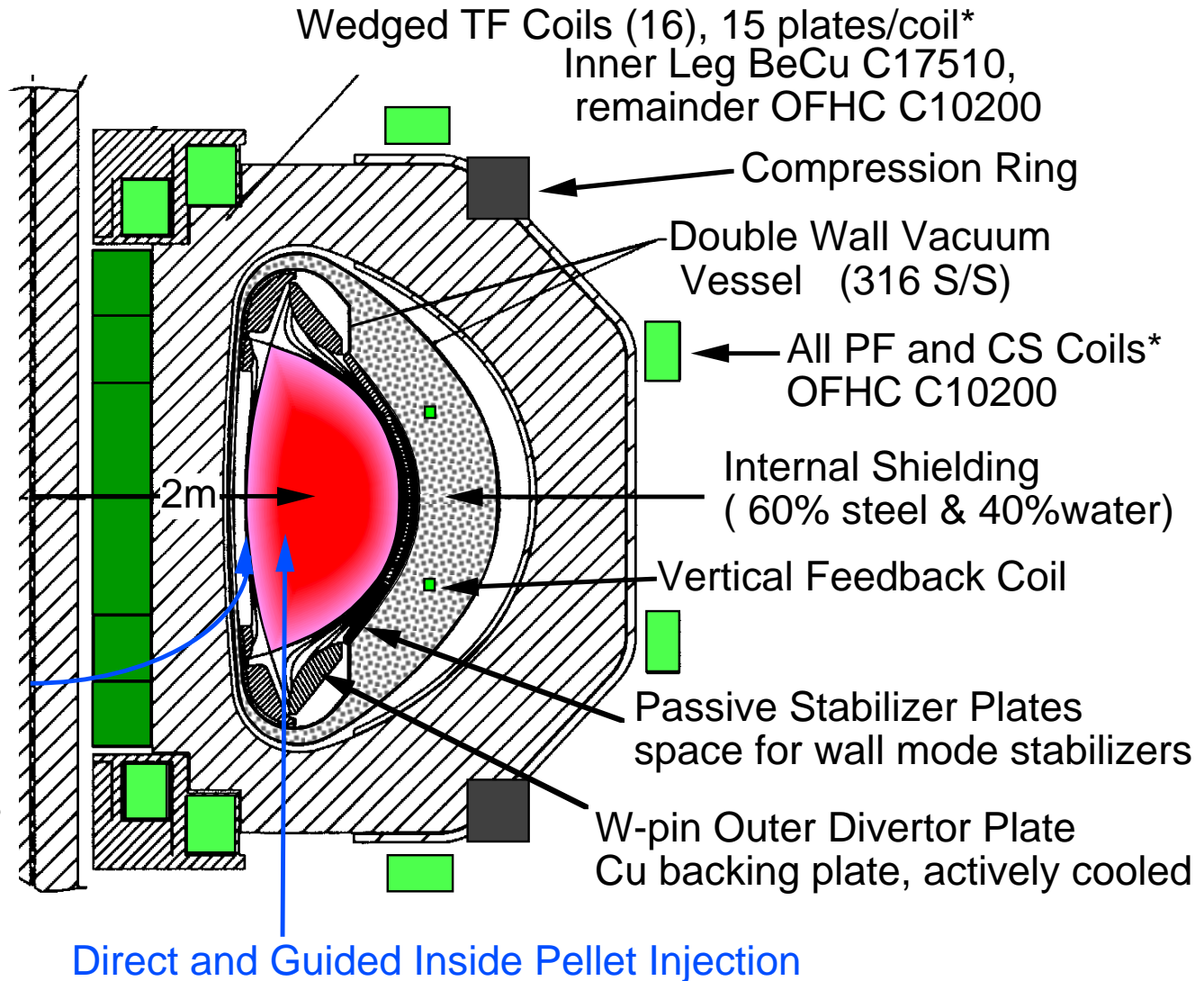

\*Coil systems cooled to 77 °K prior to pulse, rising to 373 °K by end of pulse.

## Extend FIRE Confinement Projection Activities: NSO-PAC

---

### Design Guidelines

- Similar to ITER-FEAT
  - Campbell APS paper on FIRE, ITER-FEAT presentation to TAC 7/00
  - Uckan, Wesley ANS paper
  - Meade, IAEA, ANS papers

### Confinement Database Meeting (DB4)

- Library of reproducible shots (eg Barabaschi EPS paper)

### FIRE Specific Assumptions

- JET H-mode data base of FIRE-like shots (55)
  - $1.7, n_N > 1.7, 2.7 < q_{95} < 3.5, Z_{\text{eff}} < 2, 0.3 < n/n_{\text{GW}} < 0.8$
- $\langle H(y,2) \rangle = 1.1, \langle n(0) \rangle / \langle n \rangle_v = 1.2$
- density peaking 1.2 consistent with 1-D modeling (e.g., Houlberg-ANS)
- Impurity assumption needs more analysis. Not taking credit for reduction at high density, but must make sure hi-Z ions do not get into core plasma.

Starting interactions with theory-based modeling groups.

# Guidelines for Estimating FIRE Plasma Performance

---

**Confinement (Elmy H-mode) - ITER98(y,2) based on today's data base**

$$\tau_E = 0.144 I^{0.93} R^{1.39} a^{0.58} n_{20}^{0.41} B^{0.15} A_i^{0.19} \kappa^{0.78} P_{\text{heat}}^{-0.69} H(y,2)$$

**Density Limit - Based on tokamak data base (IPBDB4)**

$$n_{20} \leq 0.80 n_{\text{GW}} = 0.80 I_p / \pi a^2$$

**Beta Limit - theory and tokamak data base**

$$\beta \leq \beta_N(I_p/aB), \quad \beta_N < 2.5 \text{ conventional, } \beta_N \sim 3 - 4 \text{ advanced}$$

**H-Mode Power Threshold - Based on today's tokamak data base**

$$P_{\text{th}} \geq (2.84/A_i) n_{20}^{0.58} B^{0.82} R a^{0.81}, \text{ same as ITER-FEAT}$$

**Helium Ash Confinement  $\tau_{\text{He}} = 5 \tau_E$ , impurities = 3% Be**

Most analyses published for FIRE have 3% Be while ITER at 1/6 the operating density has 2% Be. Some very recent cases for FIRE assume  $n_{\text{Be}} \sim 1/n$  relative to ITER or 0.4% Be.

# FIRE is a Modest Extrapolation in Plasma Confinement

Dimensionless Parameters
$\omega_c \tau$
$\rho^* = \rho/a$
$v^* = v_c/v_b$
$\beta$

Similarity Parameter
$B R^{5/4}$

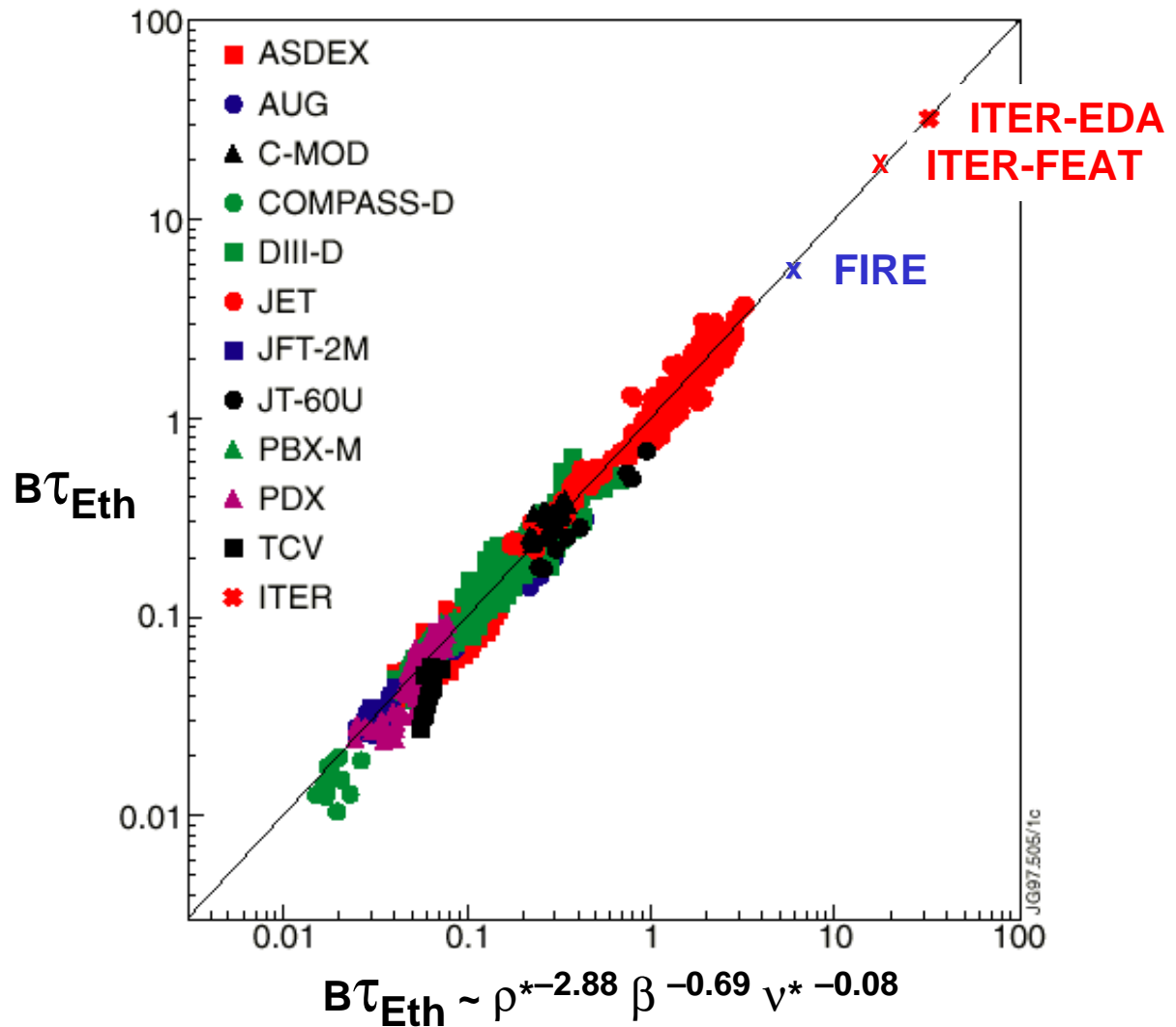

Kadomtsev, 1975

# FIRE can Access Most of the H-Mode Database

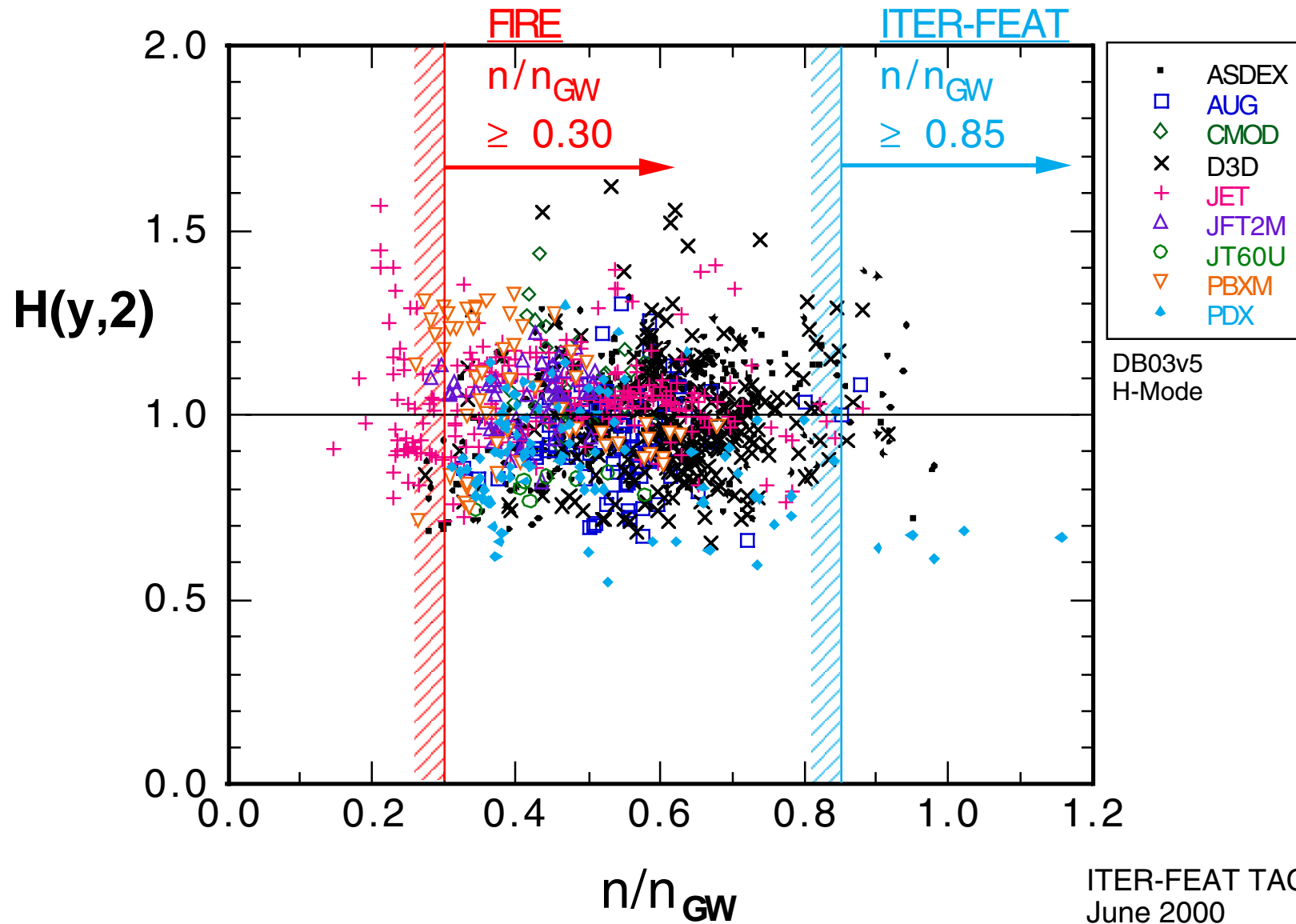



# JET H-Mode Data Selected for FIRE-like Parameters

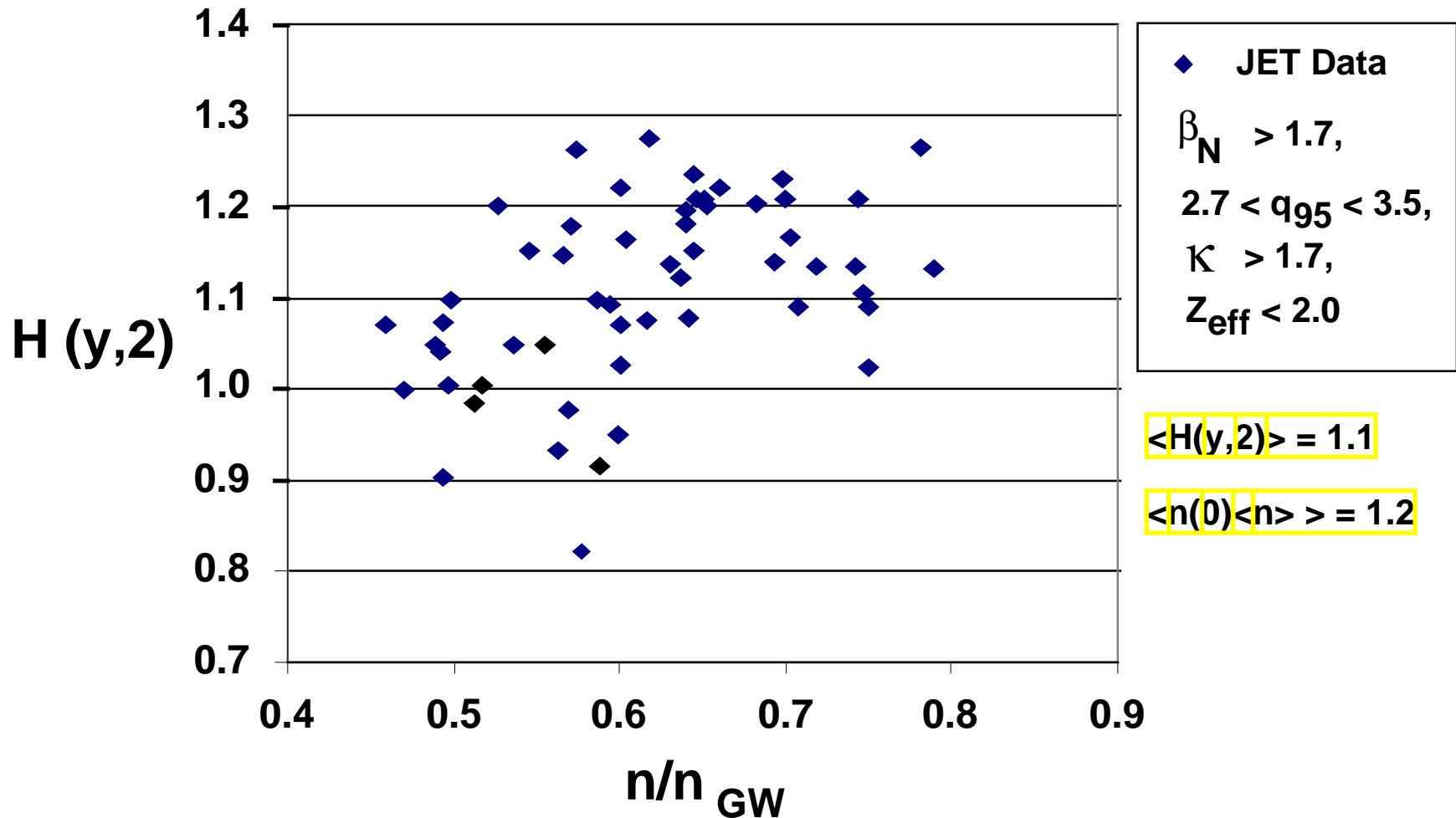

This approach discussed at IAEA(Sorrento) and at the International Confinement Database meeting (Frascati).

# Confinement Enhancement Required to Access Various Q-values Compared with JET H-Mode Data

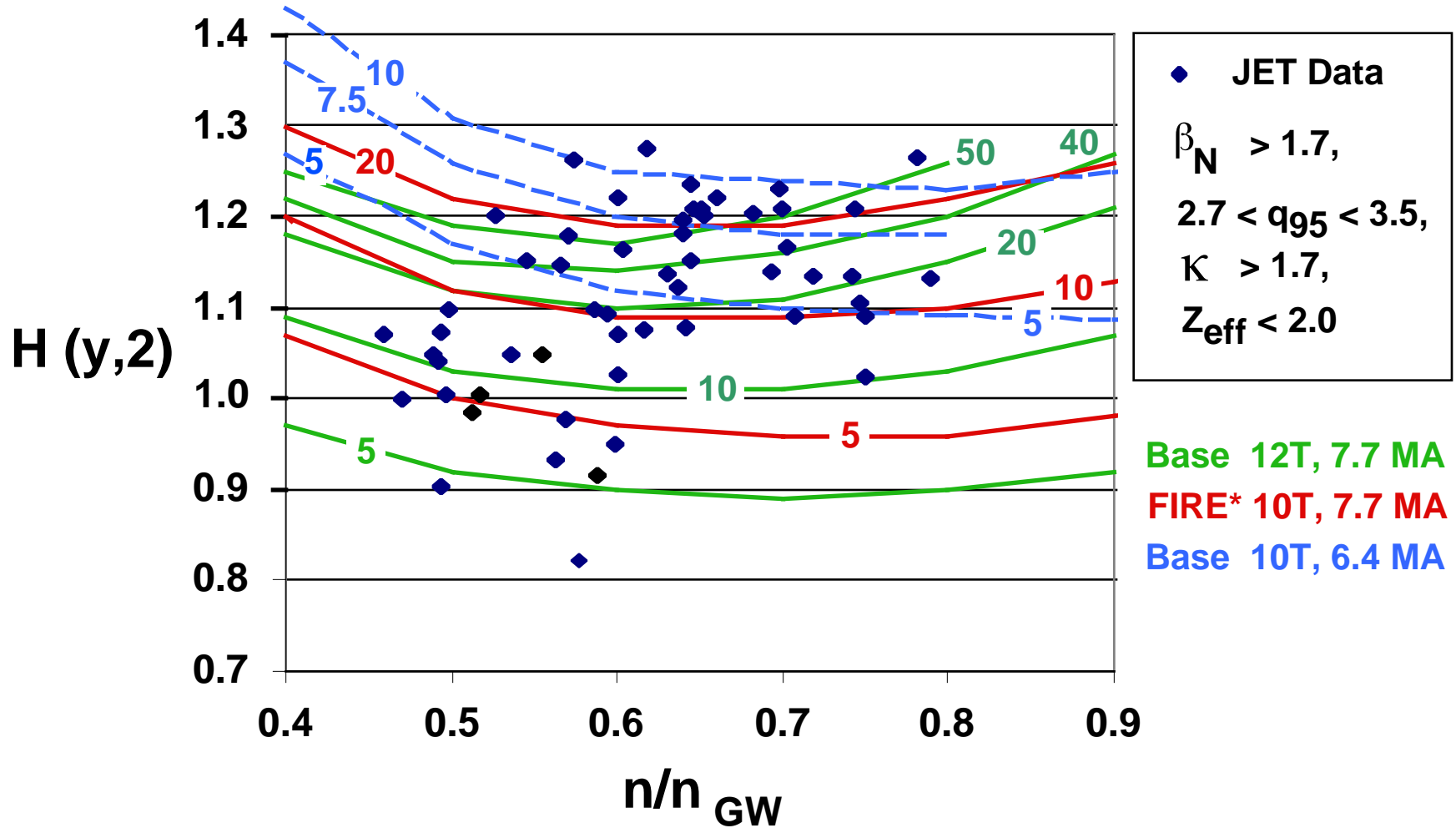

# Percentage of JET FIRE-like Data Points that Project to a Specific Alpha Heating Fraction (Q)

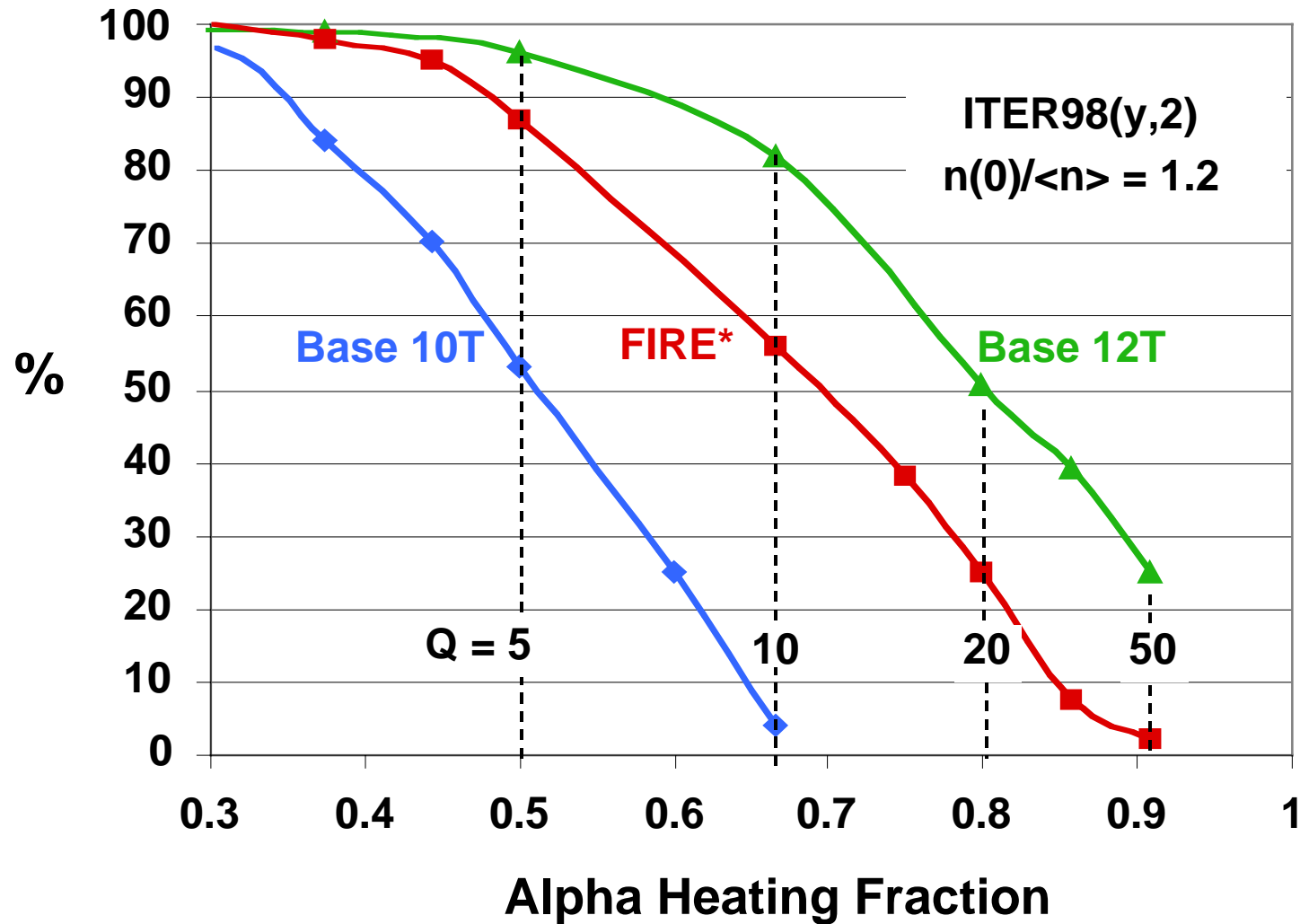

# Projections of FIRE Compared to Envisioned Reactors

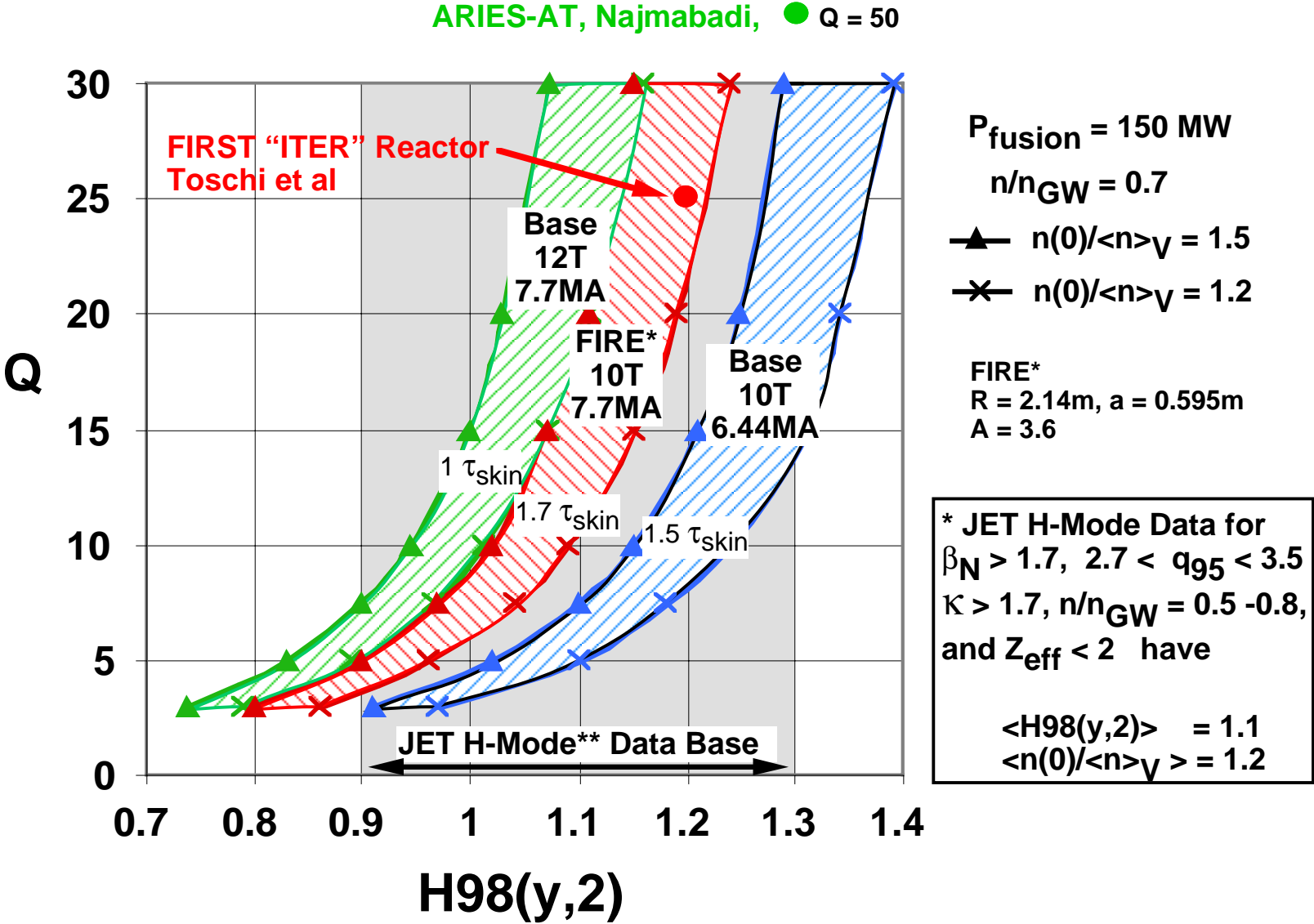

# Projections of FIRE Performance as Confinement is Enhanced Toward that Required for Attractive Reactors

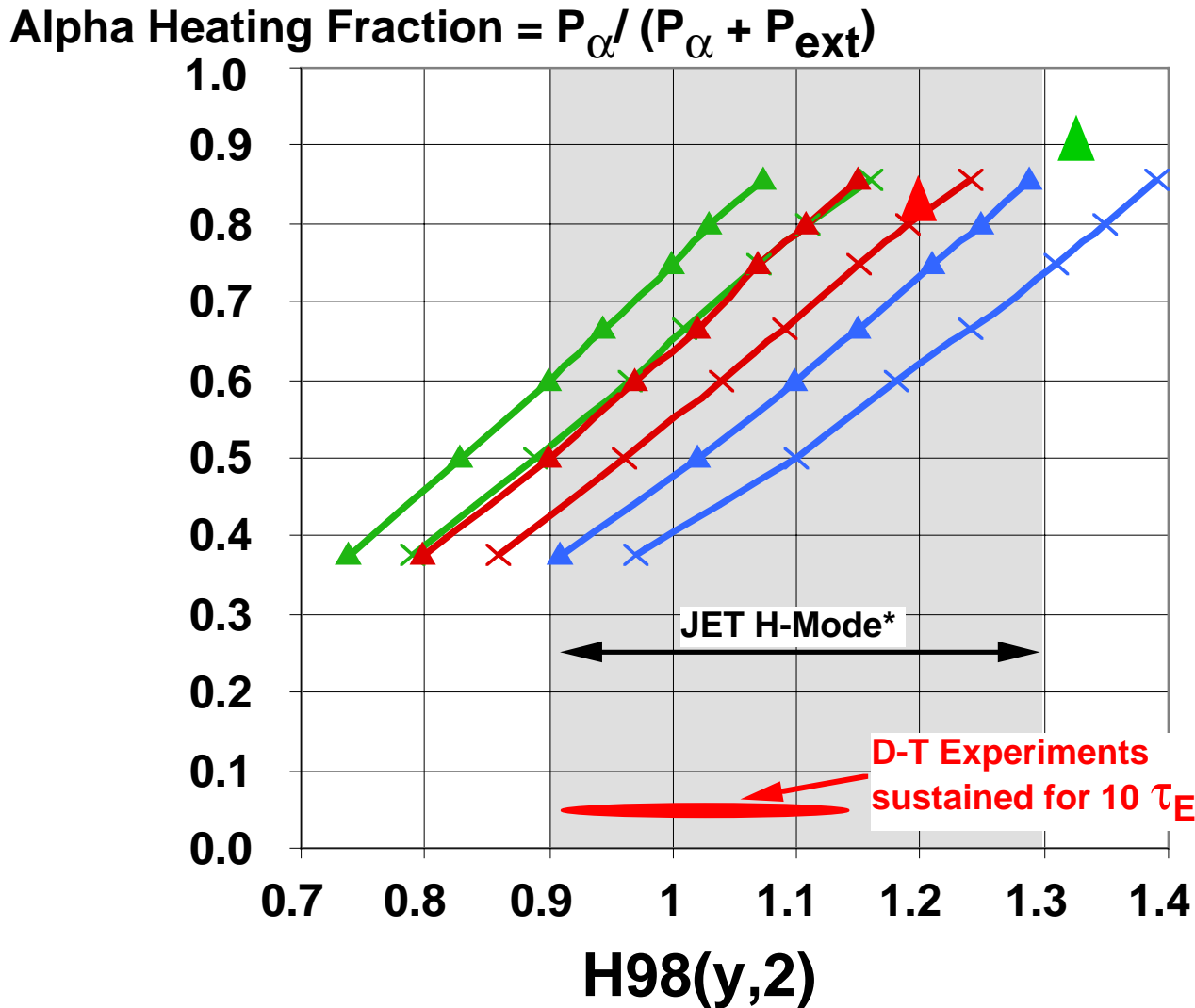

- ▲ ARIES-AT  
Najmabadi, IAEA 2000
- ▲ FIRST "ITER" Reactor  
Toschi, SOFT 2000

FIRE Projections	
<span style="color: green;">▲</span>	Base 12T, $\alpha_n = 0.5$
<span style="color: green;">×</span>	Base 12T, $\alpha_n = 0.2$
<span style="color: red;">▲</span>	FIRE* 10T, $\alpha_n = 0.5$
<span style="color: red;">×</span>	FIRE* 10T, $\alpha_n = 0.2$
<span style="color: blue;">▲</span>	Base 10T, $\alpha_n = 0.5$
<span style="color: blue;">×</span>	Base 10T, $\alpha_n = 0.2$
$P_{fusion} = 150 \text{ MW}$ $n/n_{GW} = 0.7$ $n(0)/\langle n \rangle_V = 1 + \alpha_n$	

\* JET H-Mode Range for  
 $\beta_N > 1.7, 2.7 < q_{95} < 3.5$   
 $\kappa > 1.7, Z_{eff} < 2$

Alpha heating fraction, the science goal,  
 is less sensitive to confinement uncertainty.

FIRE\* 10T, R=2.14m, 7.7 MA, H(y,2) = 1.1,  $\alpha_n = 0.2$

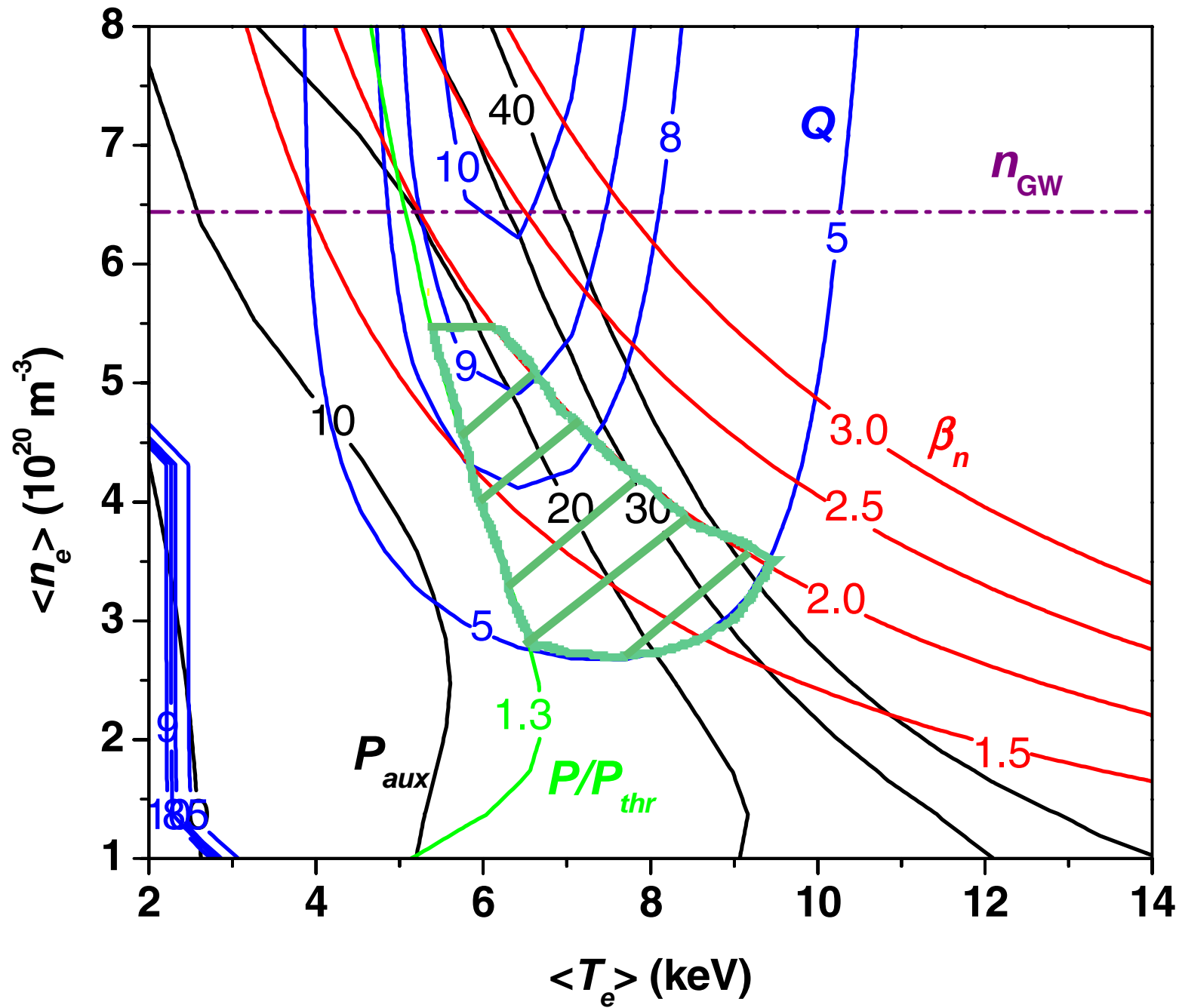

# Sensitivity Scans on FIRE\*

( $A = 3.60$ ,  $\kappa_{95} = 1.77$ ,  $\delta_{95} = 0.4$ , ITER98(y,2),  $H = 1.027$ ,  $n/n_{GW} = 0.7$ ,  $n_{Be} = 0.4\%$ )

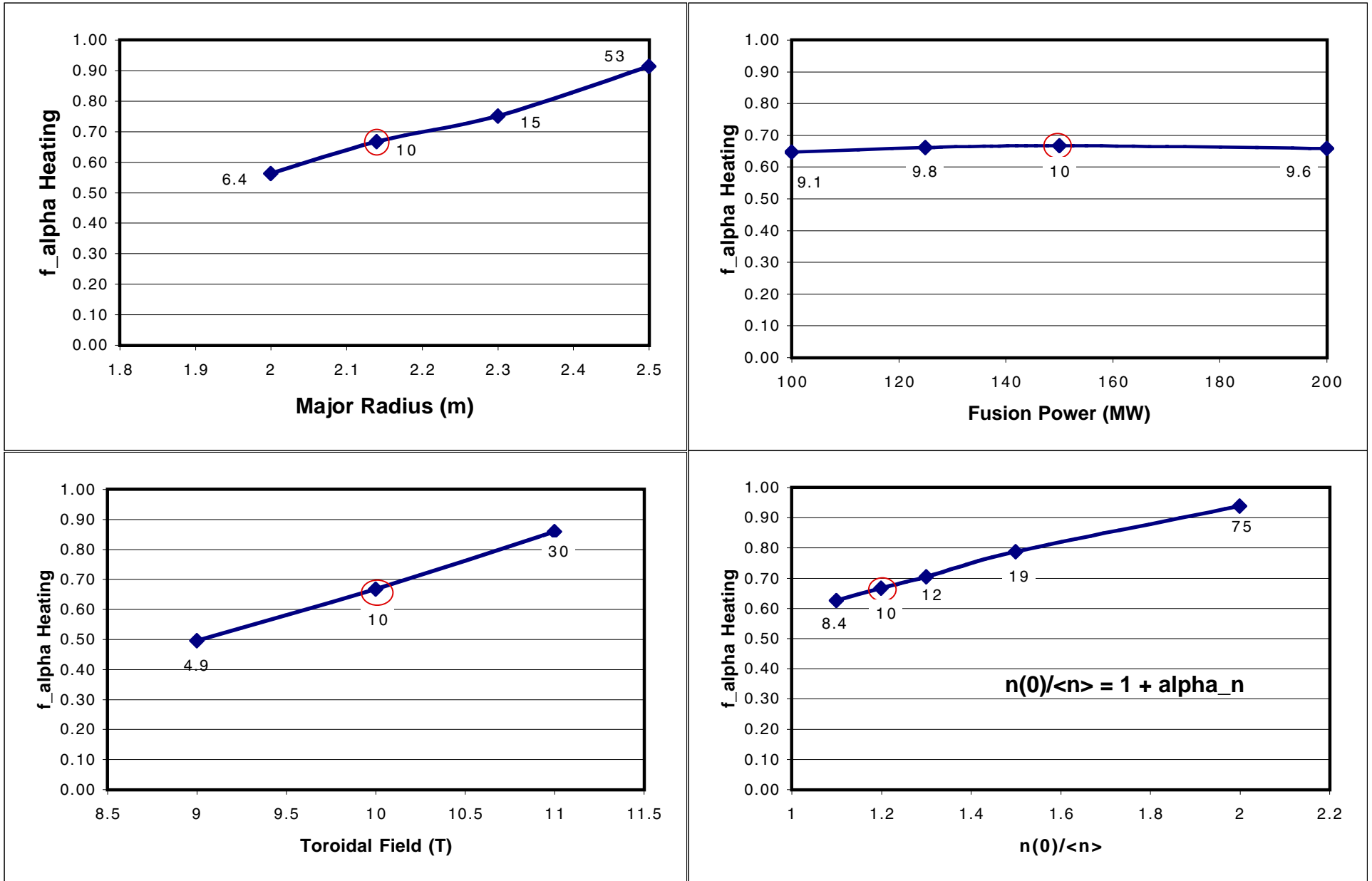

Note: kappa area would make  $H = 1.01$

# 1 1/2-D Simulation of Burn Control in FIRE

Power (MW)

10 T, 6.44 MA, ~20 s FT

<http://fire.pppl.gov>

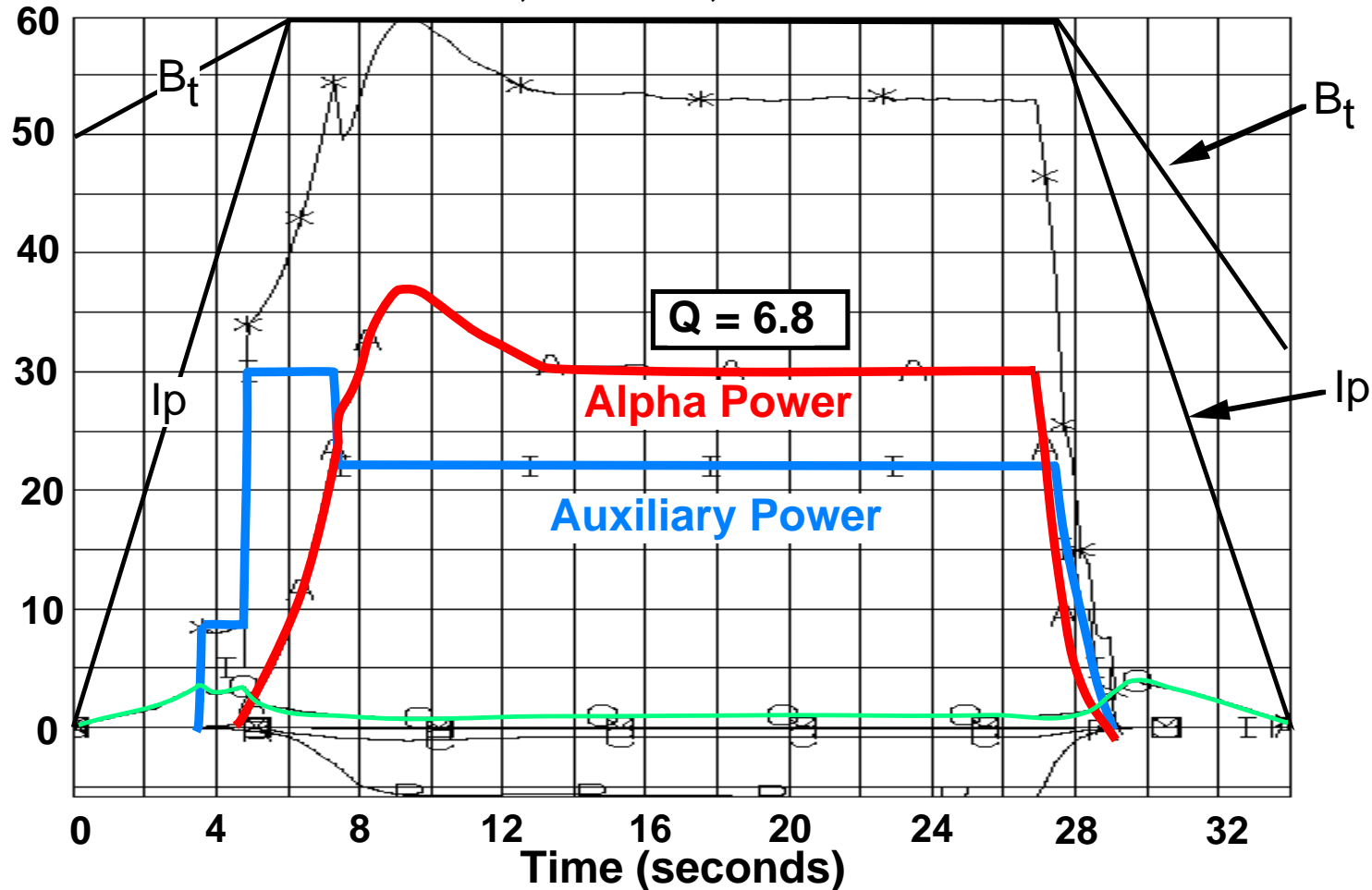

- ITER98(y, 2) scaling with  $H(y,2) = 1.1$ ,  $n(0)/\langle n \rangle = 1.25$  and  $n/n_{GW} = 0.59$ 
  - Pulse Duration  $\approx 30 \tau_E$ ,  $6 \tau_{He}$  and  $\sim 1.5 \tau_{skin}$



## FIRE could Access High-Gain Advanced Tokamak Regimes for Long Durations

---

- The coupling of advanced tokamak modes with strongly burning plasmas is a generic issue for all advanced “toroidal” systems. The VLT PAC, Snowmass Burning Plasma and Energy Subgroup B recommended that a burning plasma experiment should have AT capability.
- FIRE, with strong plasma shaping, flexible double null poloidal divertor, low TF ripple, dual inside launch pellet injectors, and space reserved for the addition of current drive (LHCD) and/or a smart conducting wall, has the capabilities needed to investigate advanced tokamak regimes in a high gain burning plasma.
- The LN inertially cooled TF coil has a pulse length capability  $\sim 250$  s at 4T for DD plasmas. This long pulse - AT capability rivals that of any existing divertor tokamak or any under construction. **The coils are not the limit.**
- Recent AT regimes on DIII-D (Shot 98977) sustained for  $\sim 16 \tau_E$  serve as demonstration discharges for initial AT experiments on FIRE. Need to develop self-consistent scenarios with profile control on FIRE with durations  $\sim 3 \tau_{\text{skin}}$ .

# FIRE could Access “Long Pulse” Advanced Tokamak Mode Studies at Reduced Toroidal Field.

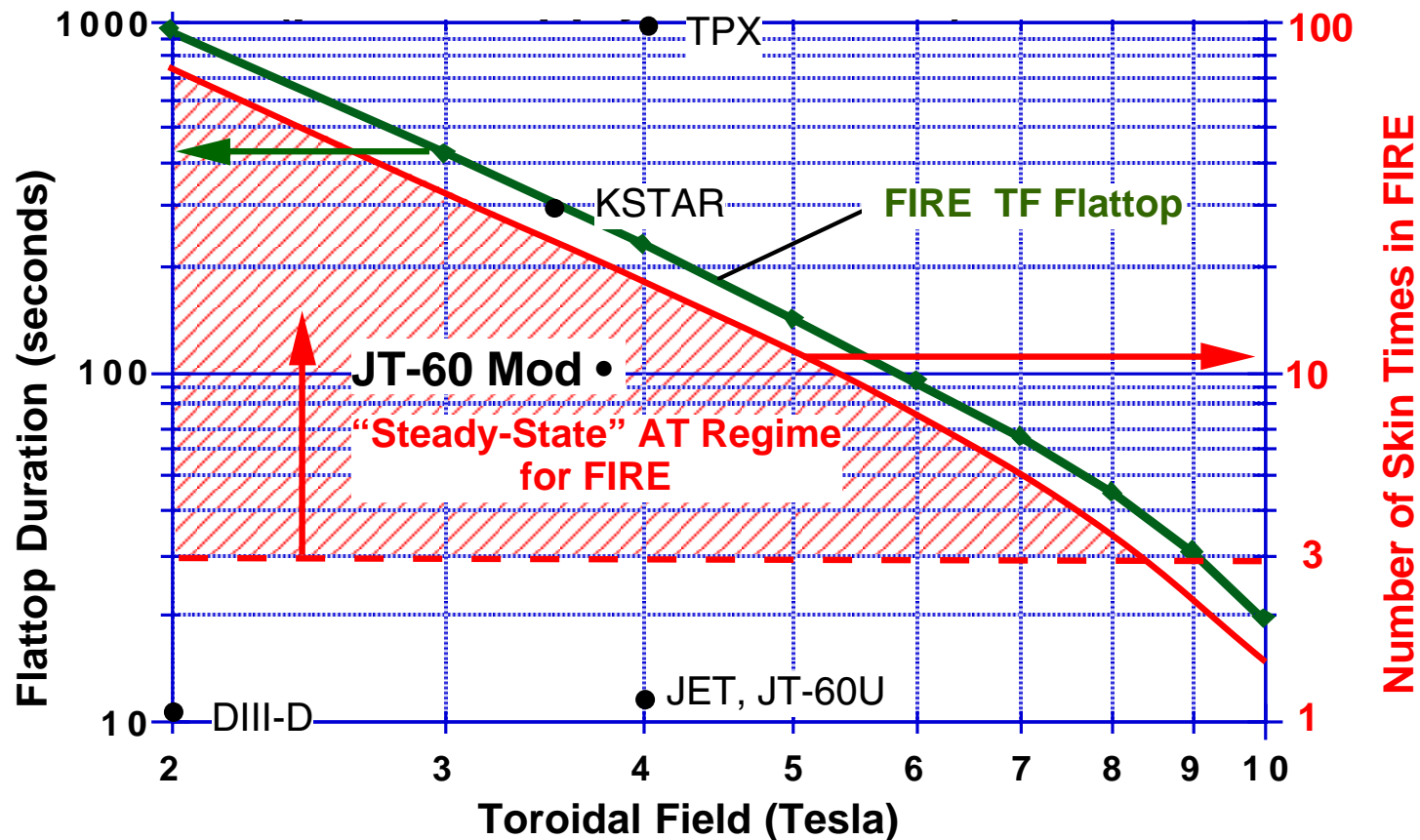

Note: FIRE is  $\approx$  the same physical size as TPX and KSTAR.  
 At  $Q = 10$  parameters, typical skin time in FIRE is 13 s and is 200 s in ITER-FEAT .

The combination of JET-U, JT-60 Mod, KSTAR and FIRE could cover the range from steady-state non-burning advanced-tokamak modes to “quasi-equilibrium” burning plasmas in advanced tokamak modes.

# FIRE can Access MHD Regimes of Interest from Today's Data Base to those Envisioned for ARIES-RS

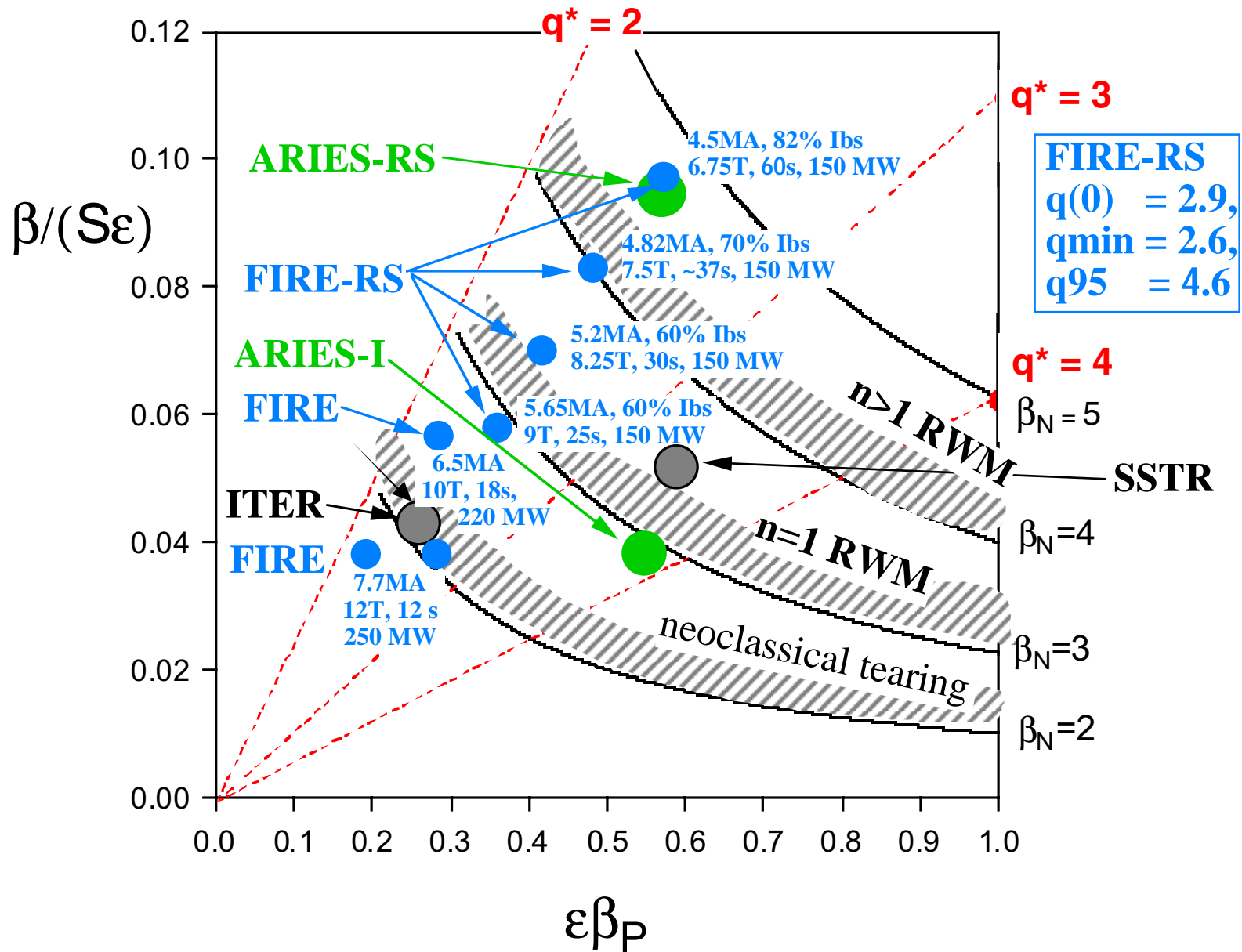

# Potential for Resistive Wall Mode Stabilization System

view of horizontal port front looking from plasma side

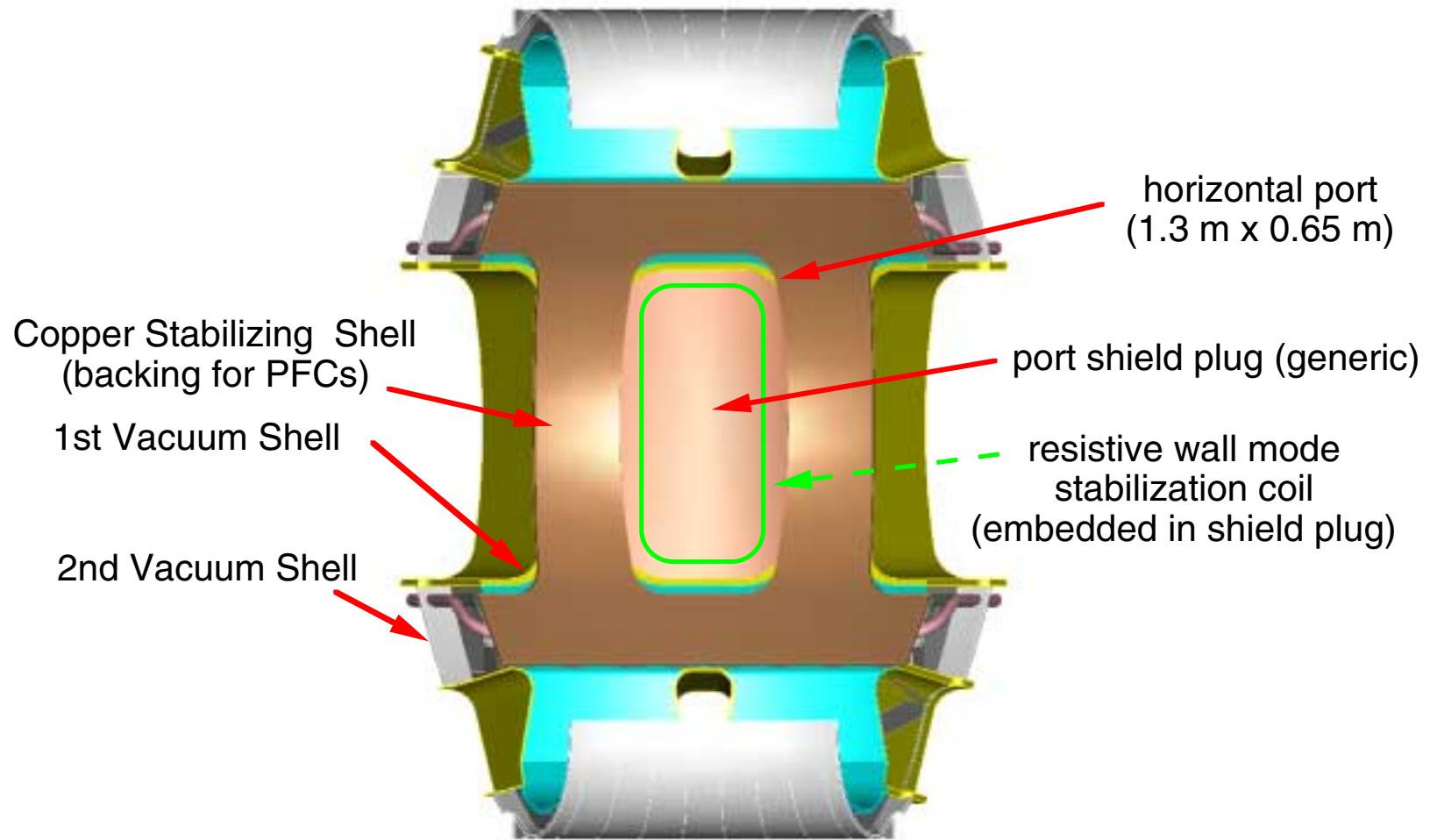

Concept under development by Columbia Univ. J. Bialek, G. Navratil, C.Kessel(PPPL) et al

# Potential Next Step Burning Plasma Experiments and Demonstrations in MFE

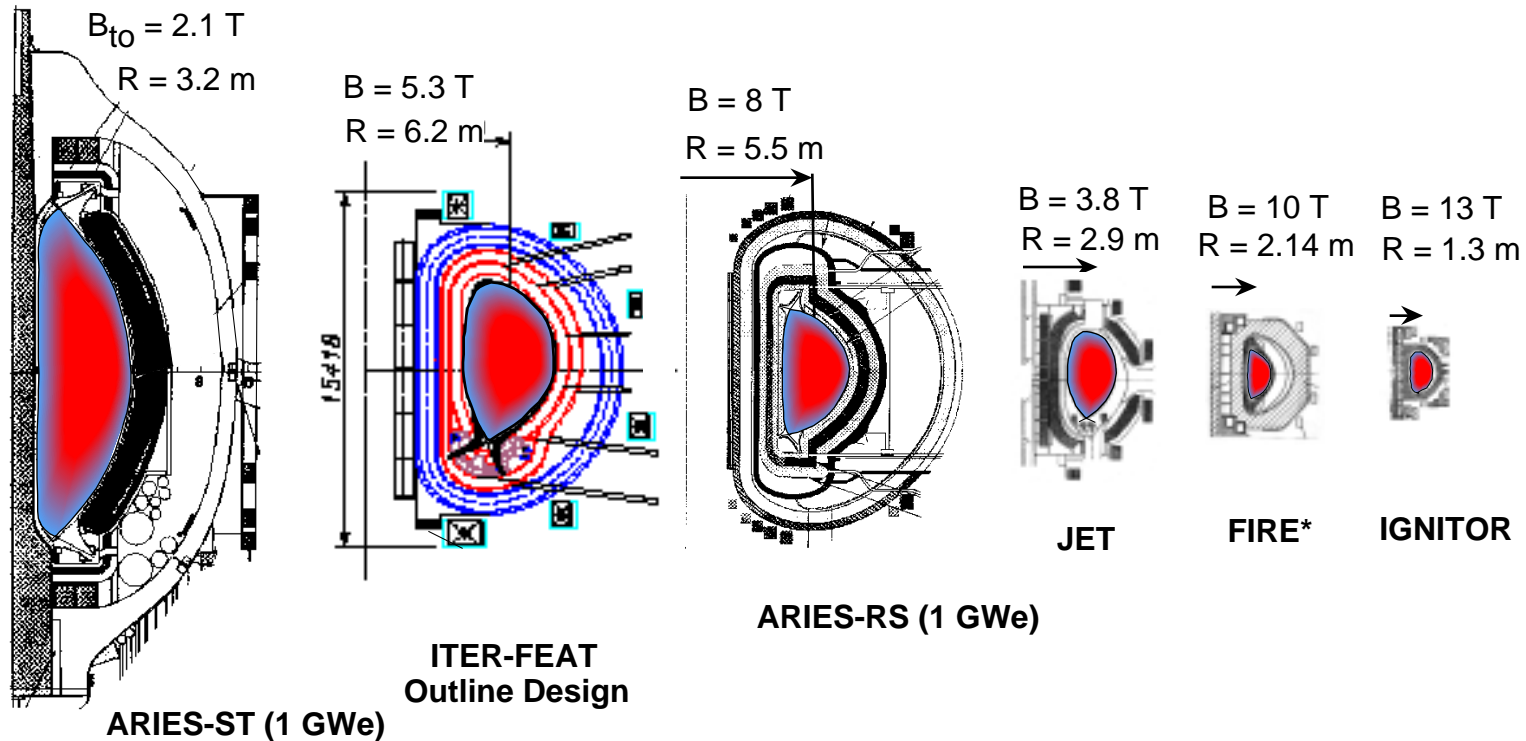

Cost Drivers	ARIES-ST	ITER-FEAT	ARIES-RS	JET	FIRE*	IGNITOR
Plasma Volume (m <sup>3</sup> )	810	828	350	95	26	11
Plasma Surface (m <sup>2</sup> )	580	678	440	150	67	36
Plasma Current (MA)	28	15	11	4	7.7	12
Magnet Energy (GJ)	29	50	85	2	7	5
Fusion Power (MW)	3000	400	2200	16	150	100
Burn Time (s), inductive	steady	300	steady*	1	20	5

\* assumes non-inductive current drive

## FIRE Power Requirements for BeCu or CuTF Coils

---

	10T (20s flattop)		12T (12s flattop)	
BeCu	Peak Power (MW)	Peak Energy (GJ)	Peak Power (MW)	Peak Energy (GJ)
TF	490	11.5	815	11.5
PF	250	2.2	360	3.7
RF	60	1	60	0.6
$\Sigma$	800	14.7	1235	15.8
Grid	550 (TF&RF)	12.5	600 (TFbase)	10.9
MG	250 (PF)	2.2	635 (TFsupp&PF&RF)	4.9

	10T (45s flattop)		12T (25s flattop)	
Cu	Peak Power (MW)	Peak Energy (GJ)	Peak Power (MW)	Peak Energy (GJ)
TF	267	12.6	345	13.2
PF	250	5	360	4.6
RF	60	2.3	60	1.3
$\Sigma$	577	19.9	765	19.1
Grid	577 (All Systems)	19.9	404 (TF&RF)	14.5
MG	0	0	360 (PF)	4.6

Wedged TF coil design requires BeCu (68% IACS) for the TF center leg.

Bucked and Wedged design could use Cu (100% IACS) for the TF coil.

# Preliminary FIRE Cost Estimate (FY99 US\$M)

---

	Estimated Cost	Contingency	Total with Contingency
1.0 Tokamak Core	252.2	75.2	323.0
1.1 Plasma Facing Components	65.0	17.0	
1.2 Vacuum Vessel/In-Vessel Structures	35.2	9.7	
1.3 TF Magnets /Structure	113.8	37.2	
1.4 PF Magnets/Structure	28.4	8.5	
1.5 Cryostat	1.8	0.5	
1.6 Support Structure	7.5	2.2	
2.0 Auxiliary Systems	134.6	39.3	173.9
2.1 Gas and Pellet Injection	7.1	1.4	
2.2 Vacuum Pumping System	13.0	2.0	
2.3 Fuel Recovery/Processing	7.0	1.0	
2.4 ICRF Heating	107.4	34.9	
3.0 Diagnostics (Startup)	22.0	4.9	26.9
4.0 Power Systems	177.3	42.0	219.3
5.0 Instrumentation and Controls	18.9	2.5	21.4
6.0 Site and Facilities	151.4	33.8	185.2
7.0 Machine Assembly and Remote Maintenance	88.3	21.8	110.1
8.0 Project Support and Oversight	100.1	15.0	115.1
9.0 Preparation for Operations/Spares	16.2	2.4	18.6
<b>Preconceptual Cost Estimate (FY99 US\$M)</b>	<b>960.9</b>	<b>236.9</b>	<b>1193.5</b>

Assumes a Green Field Site with **No** site credits or significant equipment reuse.

This estimate is work in progress and will be reviewed in the winter 2000.

**October 13, 2000**

# Timetable for “Burn to Learn” Phase of Fusion

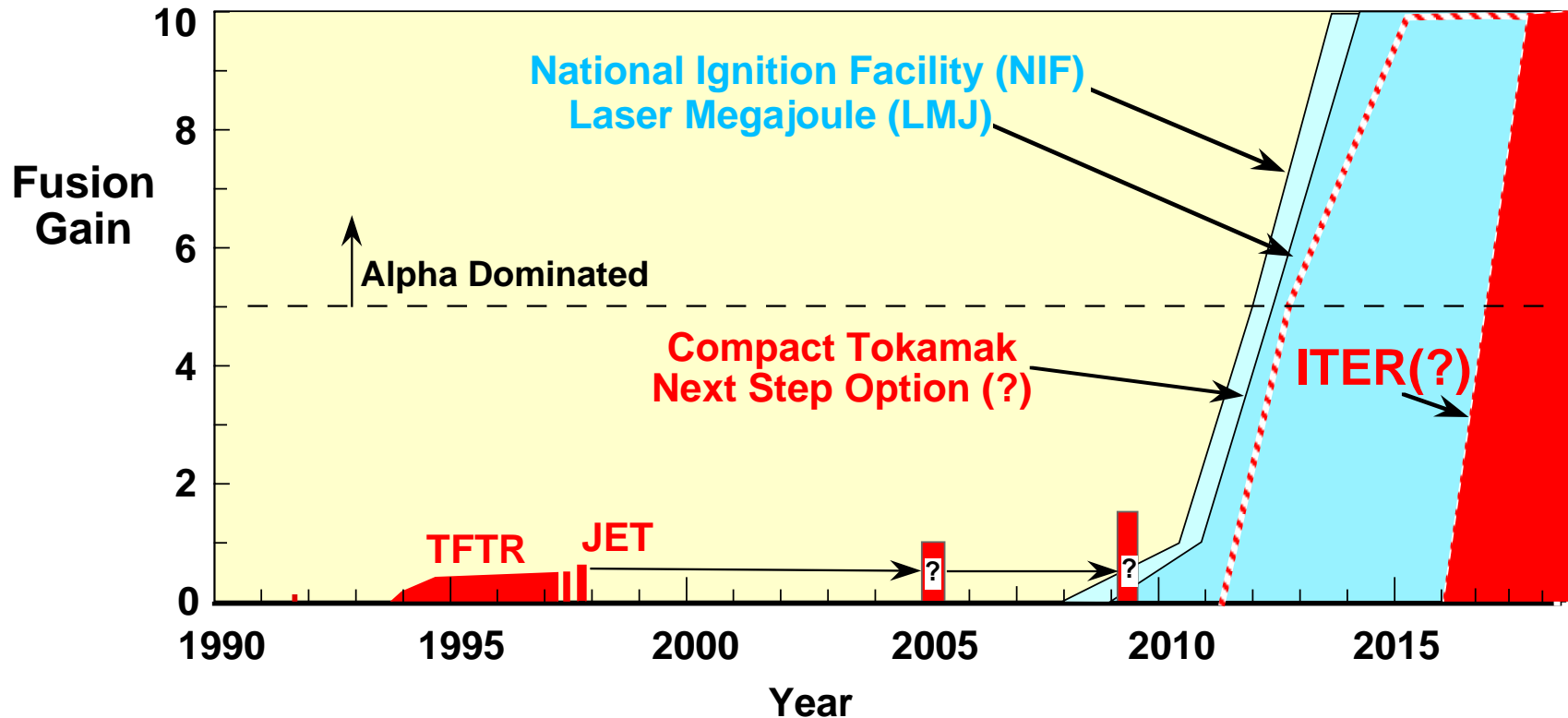

- Even with ITER, the MFE program will be unable to address the alpha-dominated burning plasma issues for  $\geq 15$  years.
- Compact High-Field Tokamak Burning Plasma Experiment(s) would be a natural extension of the ongoing “advanced” tokamak program and could begin alpha-dominated experiments by  $\sim 10$  years.
- **More than one high gain burning plasma facility is needed in the world program.**
- The information “exists now” to make a technical assessment, and decision on MFE burning plasma experiments for the next decade.



# Timetable for a Major Next Step in MFE

FY	2000	2001	2002	2003
----	------	------	------	------

- ♦ EU Airaghi Report
- ♦ FuSAC Report
- ♦ ITER-EDA Extension Complete
- ♦ JA Decision ITER/JT-60 SC
- ♦ FESAC BP Report
- ♦ EU Response to Airaghi Report
- ♦ EU FP 6 Start

## NSO/FIRE Activities

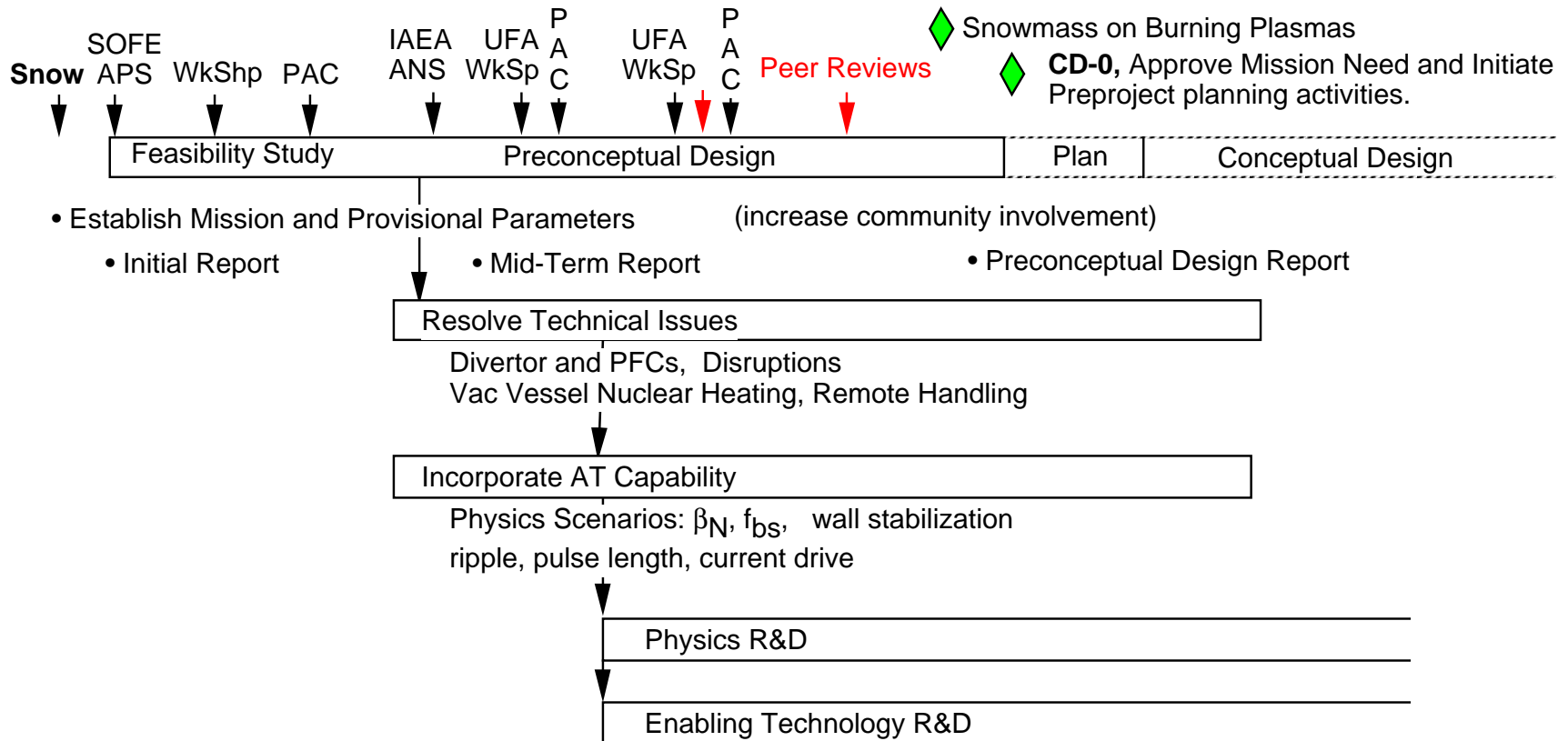

## **Some Initiatives Driven by a Next Step Experiment**

---

- Transport and Turbulence in Burning Plasmas(session at next TTF meeting?)
  - Physics based modeling
    - Multi-Mode at Lehigh - Bateman, Kritz et al: have initiated studies
    - Gyro-fluid at GA - Kinsey, Waltz, PPPL- Hammett - just beginning
    - Pedestal physics is crucial - plasma density control and high triang.
  - Similarity analysis and projection
    - DIII-D/C-Mod - extension of existing programs
- Macroscopic Stability
  - Analysis/Evaluation of Base and AT(e.g., RS) - Jardin/Ramos/Kessel
  - RWM Stabilization Initiative - Columbia Univ. et al
- Wave Particle
  - TAE/EPM Initiative - Detailed issues identified at UFA Wkshp
  - CD for AT and NTM stabilization -
- Edge Physics
  - Density Profile Control initiative - pellet fueling and pumped divertor - ORNL

**An Integrated/Coupled Simulation Model would be a powerful tool for design of a NSO, and could then be benchmarked using an NSO.**

## Major Conclusions of the FIRE Design Study

---

- Exploration, understanding and optimization of fusion-dominated (high-gain) burning plasmas are critical issues for all approaches to fusion.
- The tokamak is a cost-effective vehicle to investigate fusion-dominated plasma physics and its coupling to advanced toroidal physics for MFE. The tokamak is technically ready for a next step to explore fusion plasma physics.
- The FIRE compact high field tokamak can address the important fusion-dominated plasma issues, many of the long pulse advanced tokamak issues and begin the coupling of fusion-dominated plasmas with advanced toroidal physics in a \$1B class facility.
- The FIRE design point has been chosen to be a “stepping stone” between the physics accessible with present experiments and the physics required for the ARIES vision of magnetic fusion energy.
- A plan is being developed for an Advanced Tokamak Next Step that will address physics, engineering and cost issues in FY 2000-2 with the goal of being ready to begin a Conceptual Design in 2003.

[\*http://fire.pppl.gov\*](http://fire.pppl.gov)

**Laboratories are Needed to Explore, Explain  
and Expand the Frontiers of Science**

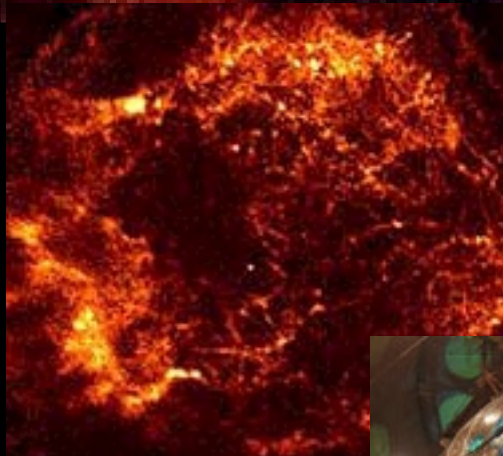

**CHANDRA**

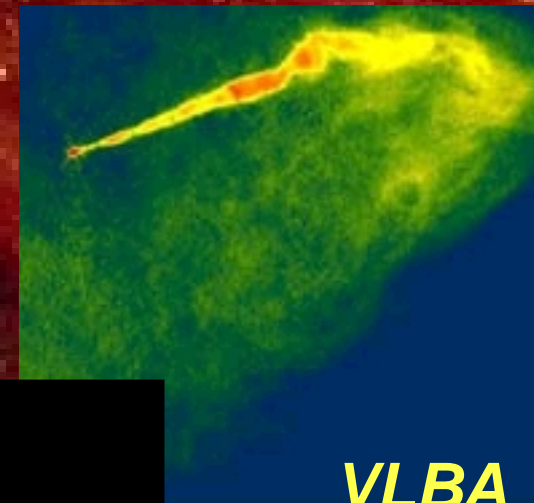

**VLBA**



**NIF**

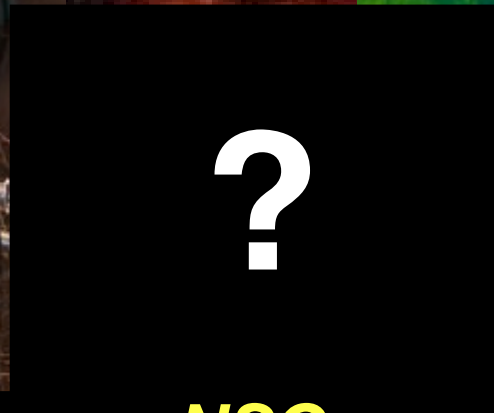

**NSO**



**HST (NGST)**

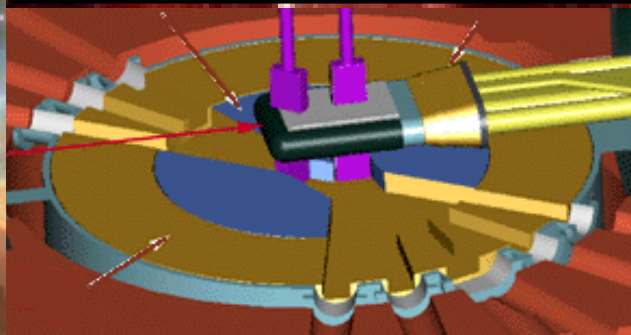

**SNS**

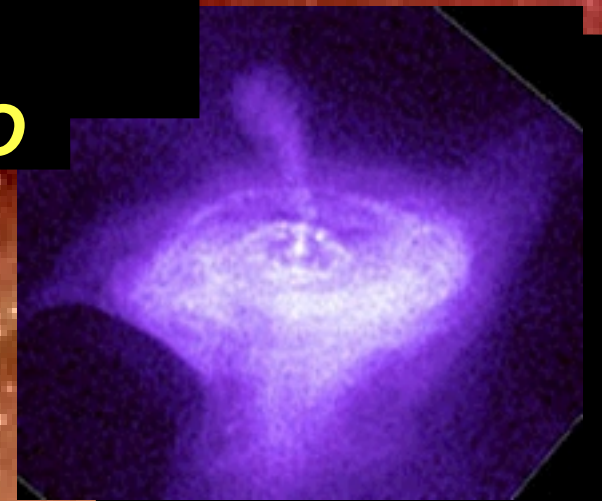

**CHANDRA**